













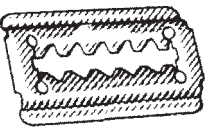

TOYOTA CLIPS & FASTENERS

<p>38568 90269-05054 Rivet: M5 Flange: 14mm G.R.: 3 - 8mm Aluminum Rivet with Steel Mandrel & Plastic Seal Gas Filler Door Blind Rivet Toyota Camry '98 - UP Box Qty. 10</p> 	<p>38569 90269-06013 Hole: M6 Rivet: M4.8 Flange: 14mm G.R.: 1.6 - 6.35mm Aluminum Rivet, Steel Mandrel & Plastic Sea Gas Filler Door Blind Rivet Toyota Camry '97 - UP Lexus IS300 2001 Box Qty. 15</p> 	<p>38611 90084-26001 Dia.: 5mm Grip: 3.2mm - 6.3mm Flange Dia.: 9.5mm Closed End Sealing Type Rivet Aluminum Rivet & Mandrel Windshield Side Moulding Toyota Camry '97 - UP Box Qty. 50</p> 	
<p>200101 Zinc & Yellow Dichromate M6.3-1.81 x 20mm (#14 x 25/32") Hex Head SEMS® Washer OD: 18mm (45/64") Hex: 10mm Honda, Nissan, Toyota Box Qty. 25</p> 	<p>280294 90468-04030 Bumper Strip Retainer Toyota '84 - UP Box Qty. 50</p> 	<p>285115 N811169-S, W705550-S300, 90189-06111 White Nylon Headlamp Mounting / Turn Signal Retainer Head Dia.: 13mm Stem length: 9mm Fits Into 11mm Hole Ford F250-F550 '99 - UP Toyota/Lexus '89 - UP Box Qty. 50</p> 	<p>292040 97606B0700, 75522-611-000, 9991-00-412 Grommet Nut #8 Screw Size 9.5mm Wide, 9.5mm Long Fits into 7mm x 7mm Hole Honda, Toyota, Nissan Box Qty. 50</p> 
<p>292050 90189-05013, MS-480002, 94841764 Nylon Nut Headlamp Bezel & Grille #10 Screw Size 12mm Wide, 12mm Long Fits into 8mm x 9mm Hole G.M. Nova '85 - UP Toyota, Mitsubishi, GM Box Qty. 50</p> 	<p>292055 96706-W1000, 90189-06013 Nylon Screw Grommet #14 (1/4") or M6.3-1.81 Screw Size Head Dia.: 20mm Stem Length: 17mm Fits Into 8mm x 8mm Hole Toyota Box Qty. 25</p> 	<p>292060 90189-04008, MB029111, 90467-12096 Nylon Grille Nut #8 Screw Size 15mm High, 12mm Wide, 16mm Long Fits Into 10mm x 10mm Hole G.M. Nova '85 - UP Toyota, Mitsubishi Box Qty. 25</p> 	
<p>292086 90662-693-003, 90189-04066 Nylon Screw Grommet #6 Screw Size Head Dia.: 14mm Stem Length: 10mm Fits Into 7mm x 7mm Hole Honda Accord '82 - UP, Toyota Box Qty. 25</p> 	<p>292205 90189-04063 Nylon Screw Grommet #6 Screw Size 14mm Long, 14mm Wide Stem Length: 10mm Fits a 6mm x 6mm Hole Used with 3mm Screws Toyota Box Qty. 25</p> 	<p>292207 90189-06193 Natural Nylon Front Bumper Nut Head Size: 14mm x 16mm Use w/ #12 Screw (M5.5) Stem Length: 10mm Toyota Camry, Avalon 2002 - UP Box Qty. 25</p> 	<p>292210 90189-06010, 75521-611-0000, 9991-00-601,96706-P0105 Nylon #10 Screw Size Grommet 13mm Wide, 13mm Long Snaps Into 8.5mm sq. Hole Used with 5mm Screws Toyota, Honda, Mazda, Nissan Box Qty. 25</p> 

TOYOTA CLIPS AND FASTENERS

Toyota

292215

90189-05012,
8941340270



Nylon
Screw Grommet
#6 Screw Size
16mm Wide, 12mm Long
Snaps Into
6mm x 10mm Hole
Used with 3mm Screws
Toyota, Isuzu
Box Qty. 25

292216

90189-06162
Front Clearance Lamp Nut
Toyota Camry '91 - '94
Headlight Adjusting Nut
Lexus
Box Qty. 10



292218

90189-06028
Plastic
Wheel Apron Retainer
Hole: M9 square
Flange: 16mm
Toyota Tacoma, T100 &
4Runner
Box Qty. 15



292220

90189-04011
Nylon
Screw Grommet
#6 Screw Size
12mm Wide, 12mm Long
Snaps Into
7mm x 7.5mm Hole
Used with 3mm Screws
Box Qty. 25



292225

90672-671-8110M1,
90189-04013
Nylon Screw Grommet
#6 Screw Size
Head Dia.: 14mm
Stem Length: 15mm
Fits Into 7mm x 7mm Hole
Honda & Toyota
Box Qty. 25



292240

90189-04019
Nylon
Screw Grommet
#8 Screw Size
14mm Long, 12mm Wide
Fits Into
6.5mm x 8.5mm Hole
Used with 4mm Screws
Toyota
Box Qty. 25



292255

90189-04014
Nylon
Screw Grommet
#8 Screw Size
10mm Wide, 10mm Long
Snaps Into
7mm x 7mm Hole
Toyota
Box Qty. 50



292260

90189-06001,
MB098145,
01281-00023
Nylon
Screw Grommet
#10 Screw Size
Head Dia.: 18mm
Stem Length: 17mm
Fits Into
8.5mm x 8.5mm Hole
Toyota, Mitsubishi, Nissan
Box Qty. 25



292270

90189-06042
90661-SC7-0030,
H001-50-841, 01651-00481,
MS-480012, 01651-00481
Nylon Screw Grommet
#8 Screw Size
Head Dia.: 16mm
Stem Length: 17mm
Fits a 8mm x 8mm Hole
Honda, Toyota, Nissan,
Mitsubishi, Mazda
Box Qty. 25



292285

90189-06018
Nylon
Screw Grommet
#10 Screw Size
14mm Wide, 14mm Long
Snaps Into
9mm x 9mm Hole
Used with 5mm Screws
Toyota
Box Qty. 25



292425

90189-06114
White Nylon
Front Fender Liner
Screw Grommet
Use with M5.5 (#12) Screw
Head Dia.: 18mm
Stem Length: 15mm
Fits into 9mm Square Hole
Toyota RAV 4
'96 - 2002
Box Qty. 15



295285

90467-05012
Plastic
Name Plate & Emblems
Tubular Nut Retainer
Hole: M6
Toyota
Box Qty. 25



302055 Box 25



302044

53789-14010A
Plastic
Inner Fender U-Nut
5mm Hole
Toyota, Lexus
Box Qty. 10

302045

90467-00002
Plastic
Fender Attaching Clip
6mm Hole
Toyota
Box Qty. 10



302052

90467-05114
Black Nylon U- Nut
Bumper/Fender Apron
M5.5 (#12) Screw Size
20mm Wide, 36mm Long
Panel Range: Up To 1mm
Center Hole to Edge: 14mm
Lexus, Toyota 2000 - UP
Box Qty. 10





355020

Headlight Mounting Clip
Toyota Camry, RAV 4
2001 - UP
Lexus IS300 2001 - UP
Box Qty. 4



TOYOTA CLIPS & FASTENERS

 <p>355145 81195-89101 Headlamp Adjusting Assembly Screw w/ Nut M5 x 50mm Toyota Pickup '84 - UP Box Qty. 10</p>	 <p>355150 81153-22520 Plastic Headlamp Adjuster Bearing Clip Toyota Cressida '85 - UP Box Qty. 25</p>	 <p>355160 81124-89101 Plastic Headlamp Spacer Hole: M7 Toyota Pickup '84 - UP Box Qty. 25</p>	 <p>415260 90467-07050, 01553-00172 Weatherstrip & Trim Panel Clip Head Dia.: 13mm Stem Length: 15mm Panel Thickness: 3mm Fits Into 5mm Hole Toyota, Nissan Box Qty. 50</p>
 <p>415269 90467-06161-01 Nylon Retaining Clip Head Dia.: 14mm Stem Length: 10mm Panel Thickness: 3mm Fits Into 5mm Hole Toyota Box Qty. 25</p>	 <p>415755 10116-41810 Trim Attaching Rivet Toyota Box Qty. 10</p>	 <p>415756 90467-07005 Seat Back Rivet Toyota, Isuzu Box Qty. 10</p>	 <p>415761 58974-0008, 89421-80270 Nylon Grille Clip 13mm Wide 22mm Long Toyota, Mitsubishi, Honda, Plymouth Laser, Isuzu, Ford Escort Box Qty. 25</p>
 <p>415762 90467-17004 Nylon Radiator Grille Clip Toyota Cressida '84 - '87 Box Qty. 10</p>	 <p>415860 90467-09145 Nylon Bumper Cover Push-Type Retainer Head Dia.: 15mm Stem Length: 12mm Fits Into 9mm Hole Camry '92 - UP Box Qty. 15</p>	 <p>415927 52161-16010 Black Nylon Rear Bumper Cover Push-Type Retainer Head Dia.: 18mm Stem Length: 28mm Fits Into 9mm Hole Toyota Tercel '88 - UP Box Qty. 10</p>	 <p>415930 90467-09008 Black Nylon Hood Insulation Retaining Clip Head Dia.: 30mm Stem Length: 17mm Panel Thickness: 6mm Fits Into 7mm Hole Toyota Cressida, Supra Box Qty. 25</p>
 <p>416019 90467-07059-22 Black Nylon Rear Door Trim & Luggage Compartment Dr Push-Type Retainer Head Dia: 15mm Stem Length: 10mm Fits Into 7mm Hole Toyota Camry & Celica '90 - UP Box Qty. 15</p>	 <p>416020 90467-08122 Natural Nylon Headliner Retaining Clip Head Dia.: 15mm Stem Dia.: 8mm Stem Length: 12mm Toyota Tacoma & T100 '92 - '97 Box Qty. 15</p>	 <p>416022 90467-08124 Black Nylon Hood Insulation Retainer Head Dia.: 25mm Stem Dia.: 8mm Stem Length: 12mm Toyota Supra '93-UP, Lexus '89 - 94 Box Qty. 15</p>	 <p>416028 90467-09096 Black Nylon Front Bumper Push-Type Retainer Head Dia.: 15mm Stem Length: 27mm Fits Into 9mm Hole Toyota Celica, Supra '89 - UP Lexus LS400 '93 - UP Box Qty. 10</p>

Toyota

TOYOTA CLIPS & FASTENERS

416031

90467-09050
Black Nylon
Hood Insulation Retainer
Head Dia.: 25mm
Stem Length: 10mm
Fits Into 7mm Hole
Lexus
Toyota Camry & Solara
'98 - '00
Box Qty. 15



416055

MB888869,
90505-SL0-003,
90467-08155
Plastic Rivet
Bumper Cover
Hole: M8
Stem: 20.5mm
Panel: 13mm, HD: 20mm
Chrysler, Mitsubishi,
Acura, Toyota
'93 - UP
Box Qty. 15



416083

90467-09139
Black Nylon
Bumper Cover &
Wheel Housing
Push-Type Retainer
Head Dia.: 18mm
Stem Length: 15mm
Fits Into 9mm Hole
Honda, Mazda &
Toyota Corolla '92 - UP
Box Qty. 15



416098

62955-20020
Nylon
Retainer with Sealer
Head Dia.: 15mm
Stem Length: 9mm
Fits Into 8mm Hole
Toyota Pick-Up Truck
Box Qty. 25

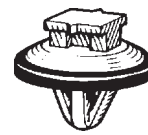

Toyota

416103

90467-06017,
9926-50-625
Nylon
Push-Type Retainer
Head Dia.: 15mm
Stem Length: 12mm
Fits Into 7mm Hole
Toyota, Mazda
Box Qty. 15



416106

90467-07146
Plastic
Phillips Head Cowl Grille
Drive-Type Rivet
Hole: M7
Flange: 16mm
P.R.: 3mm
Toyota Solara '99
Box Qty. 10



416108

90467-07043,
80999-05N07
Nylon
Push-Type Retainer
Head Dia.: 18mm
Stem Length: 11mm
(Not Including The Pin)
Fits Into 7mm Hole
Toyota, Nissan
Box Qty. 15



416115 Box 50

416114

90467-07166
Plastic
Front Fender Splash Shield
Drive-Type Rivet
Hole: M7
Flange Dia.: 20mm
G.R.: 3mm
Toyota Tercel '94 - UP
Box Qty. 15



416116

90467-09004
Plastic
Hood Insulation Retainer
Hole: M7
Head Dia.: 30mm
Stem Length: 16mm
Toyota Tacoma '95 - UP
Box Qty. 15



416120

90467-10107
Plastic - Textured Head
Fender Splash Shield Clip
Hole: M8
Head Dia.: 17mm
Stem Length: 11mm
Toyota Truck '88 - UP
Box Qty. 10



416122

90467-06175
Black Nylon
Luggage Compartment
Retainer
Head Dia.: 16mm
Stem Dia.: 6mm
Stem Length: 16mm
Toyota Solara '98 - '99
Box Qty. 15



416124

90467-10077
Butterscotch Nylon
Door Moulding Clip
with Sealer
Head Size: 15mm Square
Stem Length: 9mm
Fits Into 8mm Hole
Toyota Avalon & Corolla
'98 - '00
Box Qty. 15



416128

67921-32010
White Nylon
Scuff Plate Retainer
Small Head Dia.: 13mm
Large Head Dia.: 18mm
Stem Length: 11mm
Fits Into 9mm Hole
Toyota Avalon, Camry
& Corolla '97 - '00
Box Qty. 15



416129

90467-09006
Black Nylon
Hood Insulation Retainer
Head Dia.: 30mm
Stem Length: 17mm
Fits Into 7mm Hole
Toyota, Lexus '88 - UP
Box Qty. 15



416143 Box 100 416145 Box 25

416142

90467-07164
Fender Splash Shield
Rivet
Hole: M7
Flange: 20mm
Stem Length: 10mm
Toyota '97 - UP
Box Qty. 10













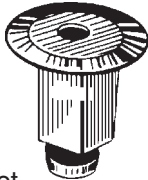



416147

90467-07201
Black Nylon
Engine Under Cover
Push-Type Retainer
Head Dia.: 20mm
Stem Length: 10mm
Fits Into 7mm Hole
Toyota Avalon, Camry,
Solara 2002 - UP
Lexus ES300/330
Box Qty. 15



TOYOTA CLIPS & FASTENERS

<p>416173 47749-58010 Black Nylon Front Fender & Bumper Cover Pin Retainer <i>(use with #416174)</i> Head Diameter: 15mm Stem Length: 25mm Lexus and Toyota 4 Runner, Highlander, Sienna & Solara 2000 – UP Box Qty. 10</p> 	<p>416174 53879-58010 Black Nylon Front Fender & Bumper Cover Clip <i>(use with #416173)</i> Width: 25mm Length: 34mm Lexus and Toyota 4 Runner, Highlander, Sienna & Solara 2000 – UP Box Qty. 5</p> 	<p>435479 90189-06003 Nylon Screw Grommet #14 (1/4") or M6.2-1.81 Screw Size Head Dia.: 18mm Stem Length: 21mm Fits Into 8mm x 8mm Hole Toyota Box Qty. 25</p> 	<p>435480 90189-06005, 098-145, 01281-00023 Body Moulding Clip M6.3 Screw Toyota, Mitsubishi, Datsun Box Qty. 25</p> 
<p>435483 90467-11063 Plastic Rocker Panel Moulding Clip Hole: M9 Toyota Previa '90 - UP Box Qty. 15</p> 	<p>435484 90904-67036 Blue Nylon Fender Moulding Clip Head Dia.: 17mm Stem Length: 17mm Toyota Highlander, Land Cruiser, Tacoma & Tundra 2001 - '02 Box Qty. 10</p> 	<p>435486 90904-67037 Red Nylon Fender Moulding Clip Head Dia.: 17mm Stem Length: 13mm Toyota Highlander, Land Cruiser, Tacoma & Tundra 2001 - '02 Box Qty. 10</p> 	<p>435487 90467-11100 Yellow Nylon Fender & Wheel Flare Moulding Clip Head Dia.: 17mm Stem Length: 17mm Toyota Highlander, Land Cruiser, Tacoma & Tundra 2000 - '02 Box Qty. 10</p> 
<p>435488 75867-30110 Rocker Panel Mldg. Clip Head: 18mm Stem Length: 22mm Fits Into 9mm Hole Toyota '97 - UP Lexus '97 - 2001 Box Qty. 15</p> 	<p>435491 75397-35010 Orange Nylon Wheel Flare Moulding Clip with Sealer Head Dia.: 17mm Stem Length: 17mm Toyota 4-Runner 2003 - UP Box Qty. 10</p> 	<p>435493 75495-35010 Blue Nylon Rocker Moulding Clip with Sealer Head Dia.: 17mm Stem Length: 10mm Toyota 4-Runner 2003 - UP Box Qty. 10</p> 	
<p>445815 67771-01010, 67771-12010, 8942264920, 9927-40-825 White Nylon Door Panel Retainer Top Head Dia.: 13mm Bottom Head Dia.: 18mm Stem Length: 14mm Overall Length: 21mm Fits Into 9mm Hole Toyota Box Qty. 25</p> 	<p>445881 67771-16080 Natural Nylon Door Trim Panel & Back Panel Upper Garnish Retainer Small Head Dia.: 13mm Large Head Dia.: 18mm Stem Diameter: 9mm Stem Length: 14mm Toyota Truck '88 - UP Box Qty. 10</p> 	<p>445885 67771-30070 Natural Nylon Door Trim Panel & Garnish Retainer Small Head Dia: 13mm Large Head Dia: 16mm Stem Diameter: 9mm Stem Length: 11mm Toyota Corolla Wagon, Tercel, T-100 & Tacoma 2WD, '92 - UP Box Qty. 25</p> 	

Toyota

TOYOTA CLIPS & FASTENERS

445886

67771-16120
Gray Nylon
Front & Rear Door
Trim Panel Retainer
Small Head Dia.: 13mm
Large Head Dia.: 19mm
Stem Length: 15mm
Fits Into a 9mm Hole
Toyota Tercel '94 - UP
Box Qty. 15



445888

67771-03030
Nylon
Door Trim Retainer
Head Dia.: 18mm
Stem Length: 14mm
Overall Length: 21mm
Fits Into 8mm Hole
Toyota Camry '88 - UP
Box Qty. 50

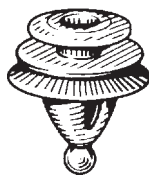

445891

67771-22010
Blue Nylon
Door Panel Retainer
Top Head Dia.: 13mm
Bottom Head Dia.: 18mm
Stem Length: 15mm
Overall Length: 21mm
Fits Into 8mm Hole
Toyota
Box Qty. 25



445978 Box 50

445977

90467-08004, 90467-8011
Nylon
Hood Seal Retaining Clip
Head Dia.: 13mm
Stem Length: 11mm
Fits Into 5mm Hole
Lexus, Toyota
Box Qty. 25



Toyota

475085

90183-03001
Front Bumper Cushion Clip
Toyota '82 - UP
Box Qty. 25



475530

53455-14020
Nylon
Hood Prop Rod Clip
Holds 8mm Dia. Rod
Snaps Into 14mm Hole
Box Qty. 15



475540

53455-33010,
53455-33011
Natural Nylon
Hood Prop Rod Clip
Holds 9mm Rod
Fits Into
10mm Square Hole
Toyota Camry '96 - UP
Box Qty. 15



TOYOTA GLASS SHOP SUPPLIES

465050

75545-12030A
Nylon
Windshield Reveal Moulding Clip
9mm Wide, 26mm Long
Toyota
Box Qty. 50



465070

75546-22021B
Windshield Reveal Moulding Clip
Toyota
Box Qty. 25



465073

75546-12010
Nylon
Windshield Moulding Clip
20mm Wide, 40mm Long
Fits Into 8mm Hole
Box Qty. 10

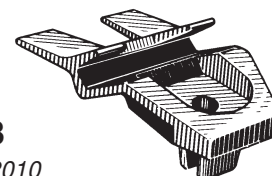

465076

75548-32010
Nylon
Windshield Mldg Clip
w/ Self Adhesive Backing
14.5mm Wide, 70mm Long
Toyota
Box Qty. 25

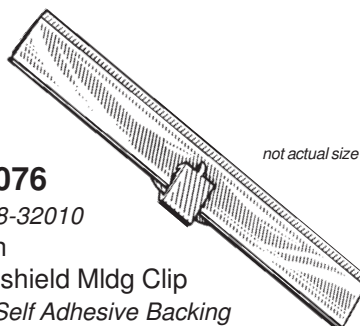

465110

75546-22030
Windshield Moulding Clip
Toyota Cressida '81 - '82
Box Qty. 10

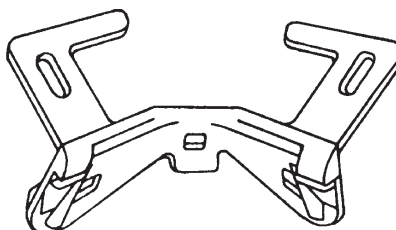

465120

75545-16020
Nylon
Windshield Moulding Clip
18mm Wide, 49mm Long,
13mm High
Toyota Corolla, Tercel '83
Box Qty. 10

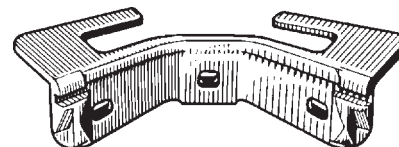

TOYOTA GLASS SHOP SUPPLIES

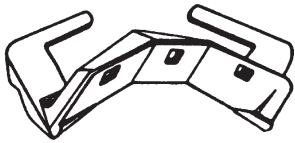

465129

75545-14060
Plastic
Windshield Moulding Clip
Toyota Celica (RWD) '82 - '85
Box Qty. 10

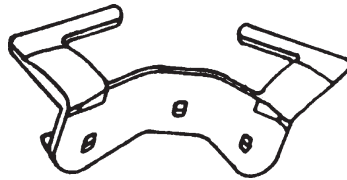

465300

75545-12040
Plastic
Windshield Moulding Clip
Toyota Corolla '84 - UP
Box Qty. 25

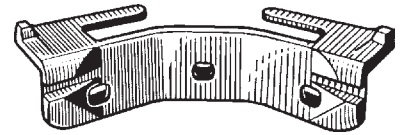

465301

75546-22050
Plastic
Windshield Moulding Clip
14mm Wide, 47mm Long,
12mm High
Toyota Cressida '85 - UP
Box Qty. 25

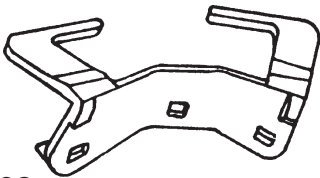

465303

75546-32010
Plastic
Windshield Moulding Clip
20mm Wide, 53mm Long,
16mm High
Toyota Camry '86 - UP
Box Qty. 25

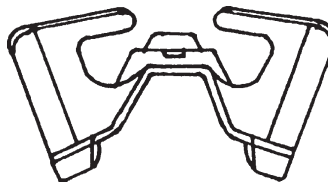

465305

75546-28010
Plastic
Windshield Moulding Clip
Toyota Van '85 - UP
Box Qty. 25

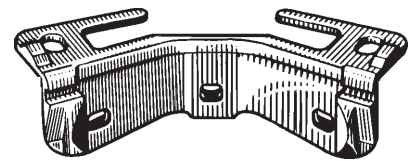

465306

75545-28010-B, 75545-88080
Nylon
Windshield Moulding Clip
18mm Wide, 49mm Long,
16mm High
Toyota Van '84
Box Qty. 25

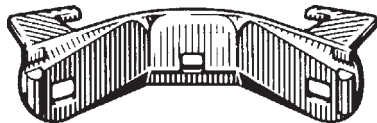

465307

75545-89101
Windshield Moulding Clip
15mm Wide, 47mm Long,
13mm High
Toyota Pick-Up Trucks
'84 - UP
Box Qty. 25

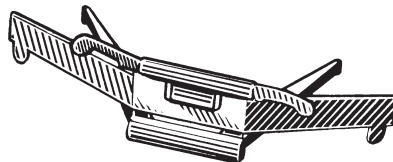

465308

75545-12050
White Plastic
Windshield Moulding Clip
Toyota Corolla (RDW) '84 - UP
Box Qty. 10

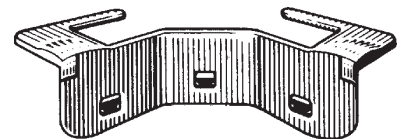

465309

75546-12030
Plastic
Windshield Moulding Clip
21mm Wide, 54mm Long,
15mm High
Toyota Corolla '84 - UP
Box Qty. 10

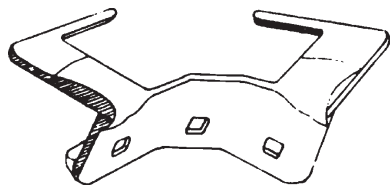

465310

75546-14080
Plastic
Windshield Moulding Clip
Toyota Celica '81 - '87
Box Qty. 25



465311

75548-12060
Yellow Plastic
Upper & Side Back Glass
Moulding Clip
Overall Length 60mm
Plastic w/ Self Adhesive
Toyota Corolla '87 - '91
Box Qty. 10



465312

75547-32010
Yellow Plastic
Upper & Side Back Glass
Moulding Clip
Toyota Camry '87 - UP
Box Qty. 15

Toyota

TOYOTA GLASS SHOP SUPPLIES

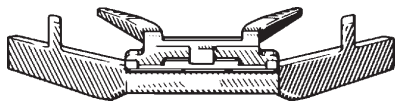

465313

75545-32020
Light Blue Nylon
Windshield Moulding Clip
12mm Wide, 66mm Long
Toyota Tercel,
Camry '87 - UP
Box Qty. 25



465314

75397-32010
White Plastic
Lower Back Glass
Moulding Clip
Toyota Camry '87 - '91
Box Qty. 15

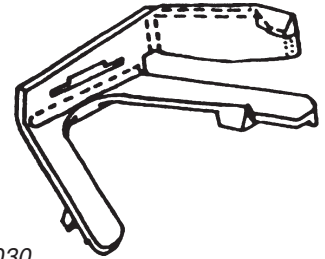

465315

75547-16030
Yellow Plastic
Windshield Moulding Clip
Right
Toyota Tercel '83 - '88
Box Qty. 10

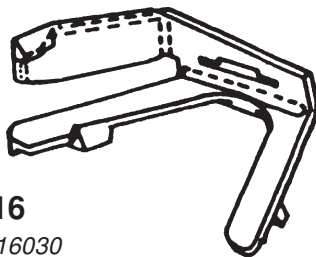

465316

75546-16030
White Plastic
Windshield Moulding Clip
Left
Toyota Tercel '83 - '88
Box Qty. 10

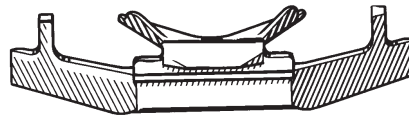

465317

75545-20060
Green Plastic
Windshield Moulding Clip
Toyota Celica '86 - UP
Box Qty. 25

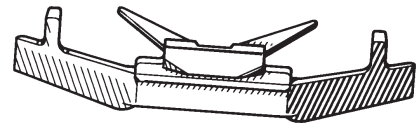

465318

75546-20060
Blue Plastic
Windshield Moulding Clip
Toyota Celica (FWD) '86 - UP
Box Qty. 25

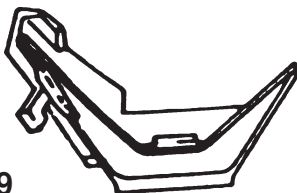

465319

75547-89105
Yellow Plastic
Windshield Chrome
Moulding Clip
Upper L.H. Corner
Toyota Truck '88 - UP
Box Qty. 10



465320

75545-89103
White Plastic
Windshield Chrome
Moulding Clip
Side L.H. & R.H.
without Center Tab
Toyota Truck '88 - UP
Box Qty. 15

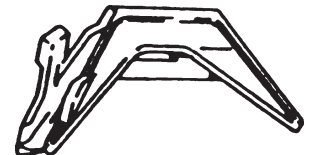

465321

75547-89104
White Plastic
Windshield Chrome
Moulding Clip
Upper R.H. Corner
Toyota Truck '88 - UP
Box Qty. 10



465322

75545-89102
White Plastic
Windshield Chrome
Moulding Clip
Side L.H. & R.H.
with Center Tab
Toyota Truck '88 - UP
Box Qty. 15

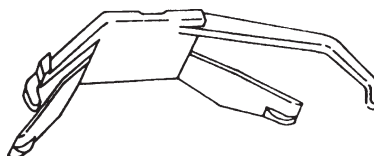

465323

75961-22030
Plastic
Windshield Moulding Clip
Top Corner R.H.
Toyota Cressida '88 - UP
Box Qty. 10

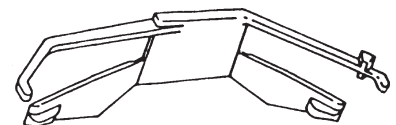

465324

75962-22040
Plastic
Windshield Moulding Clip
Top Corner
Toyota Cressida '88 - UP
Box Qty. 10

TOYOTA GLASS SHOP SUPPLIES



465325

75546-22060
 Plastic
 Windshield Sides
 Moulding Clip
 Toyota Cressida '88 - UP
 Box Qty. 15

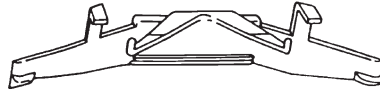

465326

75545-22070
 Plastic
 Windshield Top
 Moulding Clip
 Toyota Cressida '88 - UP
 Box Qty. 15

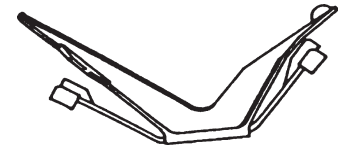

465327

75547-89106
 Black Plastic
 Windshield Chrome
 Moulding Clip
 Lower R.H. Corner
 Toyota Truck '88 - UP
 Box Qty. 10

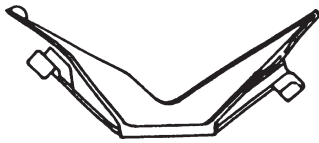

465328

75547-89107
 Gray Plastic
 Windshield Chrome
 Moulding Clip
 Lower L.H. Corner
 Toyota Truck '88 - UP
 Box Qty. 10

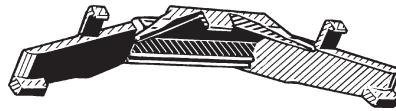

465329

75545-32030
 Natural Nylon
 Windshield Moulding Clip
 Camry '92 - UP
 Box Qty. 15



465330

75546-12060
 White Plastic
 Side Windshield
 Moulding Clip
 Toyota Corolla Sedan
 & Wagon '88 - '92
 Box Qty. 15

Toyota