

# NISSAN CLIPS & FASTENERS

<p><b>200101</b> Zinc &amp; Yellow Dichromate M6.3-1.81 x 20mm (#14 x 25/32") Hex Head SEMS® Washer O.D.: 18mm (45/64") Hex: 10mm Honda, Nissan, Toyota Box Qty. 25</p> 	<p><b>220175</b> 01135-00201 Bright Chrome Finish Bumper Bolt M6-1.0 x 12mm Head: 14mm Imports, Nissan Truck '82 - UP Box Qty. 10</p> 	<p><b>292070</b> 26023-H1000 Nylon Headlamp Adjusting Nut 8mm Sq. Hole 4.8mm Screw Datsun Box Qty. 25</p> 	<p><b>292071</b> 68425-H5000, 9991-00-503, 90662-671-0030 Nylon Nut. General Purpose #8 Screw Size 9.5mm Wide, 9.5mm Long Fits Into 7mm x 7mm Hole Honda, Datsun, Mazda Box Qty. 25</p> 
<p><b>292075</b> 96706-H9400, 96706-K1351, 96706K1300, MB106212, 90672-671-811 Screw Grommet #4 Screw Size Head Dia.: 13.5mm Stem Length: 16mm Fits Into 6mm x 6mm Hole Honda, Datsun, Mitsubishi Box Qty. 25</p> 	<p><b>292080</b> 96706-89901, 9991-00-402 Nylon Screw Grommet #6 Screw Size 9.5mm Wide, 9.5mm Long Stem Length: 16mm Fits Into 7mm x 7mm Hole Mazda, Mitsubishi, Nissan Box Qty. 25</p> 	<p><b>292105</b> 78856 R4301, 90683-693-0000 Nylon Screw Grommet #10 Screw Size 12mm Wide, 19mm Long Stem Length: 17mm Fits Into 8mm x 15mm Hole Honda &amp; Nissan Box Qty. 10</p> 	<p><b>292110</b> 62318-U7400 Grille Retainer Datsun Box Qty. 25</p> 
<p><b>292112</b> 62318-H8500, 01553-03831 Nylon Grille Retainer Datsun '82 Nissan Maxima, Stanza '90 - UP Box Qty. 25</p> 	<p><b>292130</b> 62380-U7400 Nylon Grille Retaining Clip 12mm Wide, 26mm Long Nissan Pathfinder &amp; Sentra '87 - UP Box Qty. 10</p> 	<p><b>292260</b> 90189-06001, MB098145, 01281-00023 Nylon Screw Grommet #10 Screw Size Head Dia.: 18mm Stem Length: 17mm Fits Into 8.5mm x 8.5mm Hole Toyota, Mitsubishi, Nissan Box Qty. 25</p> 	<p><b>292270</b> 90189-06042 90661-SC7-0030, H001-50-841, 01651-00481, MS-480012, 01651-00481 Nylon Screw Grommet #8 Screw Size Head Dia.: 16mm Stem Length: 17mm Fits a 8mm x 8mm Hole Honda, Toyota, Nissan, Mitsubishi, Mazda Box Qty. 25</p> 
<p><b>292295</b> 96706-N8000 Nylon Screw Grommet 12mm Wide, 15mm Long Fits 8mm x 12mm Hole Used w/ 4mm (#8) Screws Nissan Box Qty. 25</p> 	<p><b>292296</b> 01553-03361 Plastic Windshield Moulding Retainer Grommet Lower Corner Moulding (Use with #415277) Nissan Pathfinder '90 - UP Box Qty. 15</p> 	<p><b>302046</b> Black Plastic General Purpose Clip Hole: M5 Nissan, Toyota Box Qty. 10</p> 	<p><b>302047</b> 63848-D4000 Plastic Inner Fender Panel Clip Hole: M6 Nissan &amp; Infinity '89 - UP Box Qty. 15</p> 

# NISSAN CLIPS & FASTENERS

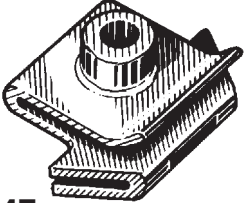
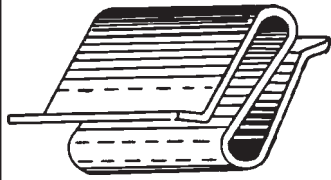

**302110**  
63812-U7400  
Plastic  
Fender Attaching Clip  
Datsun  
Box Qty. 10



**415237**  
01553-06721  
Plastic  
Drive-Type Rivet  
Front & Rear Bumper Cover  
Hole: M8  
Washer Face: 19mm  
G.R.: 3 - 6mm  
Nissan Maxima '90 - UP,  
Infinity Q45 (Rear) '90 - UP  
Box Qty. 25

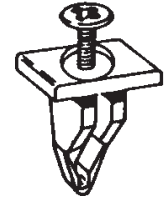

**415243**  
Plastic  
Screw Type Rivet  
Cowl Grille  
Hole: M6 Sq.  
Head: 8mm x 12mm  
G.R.: 5 - 7mm  
Nissan 300 ZX '90 - UP  
Box Qty. 25

Nissan



**415260**  
90467-07050,  
01553-00172  
Weatherstrip &  
Trim Panel Clip  
Head Dia.: 13mm  
Stem Length: 15mm  
Panel Thickness: 3mm  
Fits Into 5mm Hole  
Toyota, Nissan  
Box Qty. 50



**415270**  
90467-06054  
Black Plastic  
Trim Panel Rivet  
Datsun  
Box Qty. 25



**415278**  
01553-00545  
Nylon  
Bumper Fascia Retainer  
Head Dia.: 13mm  
Stem Length: 15mm  
Fits 5mm Hole  
Nissan Sentra '90 - UP  
Box Qty. 25

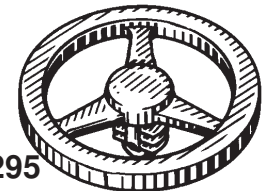

**415295**  
65832-F5000, 65846-30F00  
Nylon  
Hood Insulation Retainer  
O.D.: 38mm  
Stem Dia.: 7mm  
Stem Length: 9mm  
Nissan, Datsun '81 - UP  
Box Qty. 15

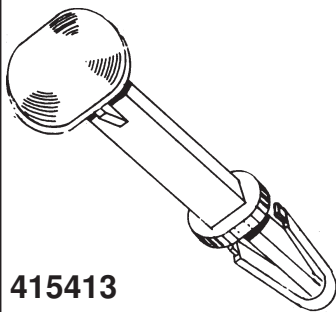

**415413**  
62089-N8520  
Bumper Cover Retainer  
Datsun '80 - UP  
Box Qty. 25

**415917 Box 25**



**415509**  
76882-57A00  
Plastic  
Drive-Type Rivet  
Body Side Moulding  
Hole: M8, Flange: 16mm  
G.R.: 4 - 8mm  
Nissan Sentra '86 - UP  
Box Qty. 10

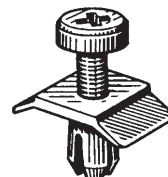

**415730**  
66824 -W1000  
Hood Moulding Clip  
(with Screw)  
Datsun  
Box Qty. 10



**415740**  
66860 01W01,  
94051993  
Nylon  
Cowl Panel to  
Reinforcement Plate &  
Engine Splash Shield Ret.  
Head Dia.: 14mm (9/16")  
Stem Length: 16mm (5/8")  
Fits Into 6mm (1/4") Hole  
Geo Storm '90 - UP  
Nissan '80 - UP  
Box Qty. 25

**415751 Box 50**



**415750**  
63844-01A00,  
NA01-56145, MNA01-56145  
Nylon  
Inner Fender Shield Ret.  
Head Dia.: 20mm (25/32")  
Stem Length: 18mm (23/32")  
Fits Into 8mm (5/16") Hole  
Ford Probe & Aspire '95 - UP  
Nissan '80 - UP  
Box Qty. 10















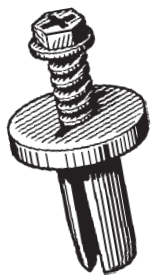

**415772**  
66814-01G00  
Black Nylon  
Cowl Grille Retainer  
Head Size: 8mm x 12mm  
Stem Length: 8mm  
Fits 6mm Sq. Hole  
Nissan Pick-Up Truck  
'86 - UP  
Box Qty. 25

**415776 Box 25**



**415775**  
80915-29A66,  
8942-431-900,  
9926-50-635  
Screw Type Drive Rivet  
Hole: M6  
Panel Range: 2mm - 5mm  
Washer Head: 20mm  
Honda, Nissan, Isuzu, etc.  
Box Qty. 10

# NISSAN CLIPS & FASTENERS

<p><b>415777</b>            90675-SB3-003            FB01-56-964, 63876-95596            Black Plastic            Cowl Vent, Air Ducts &amp;            Fender Splash Shield            Screw Type Rivet            Hole: M8            Washer Face: 20mm            Grip Range: 2.0 - 5.0mm            Honda, Nissan, Mazda            Box Qty. 10</p> 	<p><b>415865</b>            91545-SE0-0030-W1,            63848-01G00            Nylon            Push-Type Retainer            Head Dia.: 20mm            Stem Length: 14mm            Fits Into 8mm Hole            Box Qty. 25</p> 	<p><b>415905</b>            63844-01A99            Nylon            Push-Type Retainer            Head Dia.: 17mm            Stem Length: 18mm            Fits into an 8mm Hole            Nissan            Box Qty. 25</p> 	
<p><b>415920</b>            63844-00100,            8942211500            Nylon            Screw Retainer            Fits into a 7mm Hole            Isuzu, Nissan            Box Qty. 25</p> 	<p><b>415925</b>            90684-SA5-0030,            8942981190,            10998-30880            Nylon            Push-Type Retainer            Head Dia.: 15mm            Stem Length: 11mm            Fits in a 6mm Hole            Nissan, Honda, Isuzu            Box Qty. 25</p> 	<p><b>415940</b>            62869-N4700            Nylon            Retaining Clip            Head Dia.: 14mm            Stem Length: 11mm            Fits in a 6mm Hole            Panel Thickness: 4mm            Nissan            Box Qty. 25</p> 	<p><b>416007</b>            80875-85E00            Black Nylon            Trim Panel Retainer            Head Dia.: 10mm            Stem Length: 10mm            Stem Diameter: 4mm            Nissan Maxima '89 - UP            Box Qty. 25</p> 
<p><b>416095</b>            01553-09321            Black Nylon            Front Fender Push-Type            Retainer (Reusable)            Head Dia.: 20mm            Stem Length: 9mm            (Not Including The Pin)            Fits Into 8mm Hole            Nissan Maxima, 300ZX            '94 - UP            Box Qty. 15</p> 	<p><b>416134</b>            63854-01A00            Nylon            Front Bumper Fascia            Push-Type Retainer            Head Dia.: 20mm            Stem Length: 20mm            Fits Into 8mm Hole            Nissan 300ZX '90 - UP            Box Qty. 15</p> 	<p><b>416137 Box 25</b>  <b>416136</b>            01553-09241            Black Nylon            Push-Type Bumper Retainer            Head Dia.: 18mm            Stem Length: 15mm            (Not Including The Pin)            Fits Into 10mm Hole            Nissan 240SX &amp;            Maxima '94 - UP            Box Qty. 10</p> 	<p><b>416159</b>            66820-3S500-C1            White Nylon            Cowl Vent Retainer            Top Head Dia.: 13mm            Bottom Head Dia.: 16mm            Stem Dia.: 4mm            Stem Length: 13mm            Nissan Frontier, Xterra            '98 - UP            Box Qty. 25</p> 
<p><b>435480</b>            90189-06005,            098-145, 01281-00023            Body Moulding Clip            M6.3 Screw            Toyota, Mitsubishi, Datsun            Box Qty. 25</p> 	<p><b>445800</b>            Nylon            Door Trim Panel Clip            Datsun            Box Qty. 25</p> 	<p><b>445805</b>            76906-T3000,            90467-11005            Weatherstrip Clip            Honda, Nissan            Box Qty. 25</p> 	<p><b>445970</b>            01553-00051            Trim Panel Clip            Datsun            Box Qty. 25</p> 

# NISSAN CLIPS AND FASTENERS



**475605**  
Metal  
Front Bumper  
Cushion Retainer  
Infinity Q45 '91 - UP,  
Nissan Sentra '87-UP  
Box Qty. 15



**475710**  
62228-51S00  
Front Bumper  
Retainer  
Nissan 300ZX  
'92 - UP  
Box Qty. 10

Nissan

# NISSAN GLASS SHOP SUPPLIES

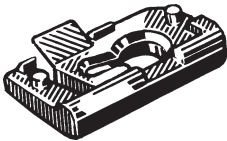

**465040**  
72825-47400  
Plastic Windshield Reveal  
Moulding Clip  
Datsun, Mazda  
Box Qty. 25



**465061**  
72727-W1000  
White  
Windshield Reveal  
Moulding Clip  
Datsun, Nissan  
Box Qty. 25

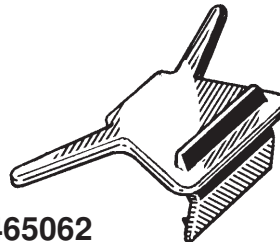

**465062**  
72727 W1098  
Black  
Windshield Reveal  
Moulding Clip  
Datsun, Nissan  
Box Qty. 25

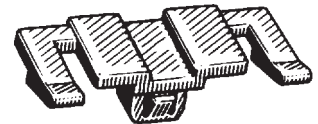

**465100**  
80866-01A00  
Windshield Reveal  
Moulding Clip  
Datsun  
Box Qty. 25



**480035**  
542290201P  
Window Crank Handle  
Retaining Clip  
Datsun  
Box Qty. 50