

# TAPPING SCREWS

## TAPPING SCREWS PHILLIPS OVAL



All Items On This Page  
Packaged 100 Per Box  
Unless Otherwise  
Noted In Parenthesis

SIZE	HEAD # SIZE	CHROME	ZINC CHROMATE	BLACK OXIDE
#4 x 3/8" .....	REG .....			110001
#4 x 1/2" .....	REG .....	105030		110002
#4 x 5/8" .....	REG .....			110003
#4 x 3/4" .....	REG .....	105040		110004
#4 x 1" .....	REG .....	105060		110005
#6 x 1/2" .....	REG .....	105070		110006
#6 x 5/8" .....	REG .....	105080		
#6 x 3/4" .....	REG .....	105090		110007
#6 x 1" .....	REG .....	105100		110008
#6 x 1-1/4" .....	REG .....	105110		110009
#8 x 3/8" .....	#6 .....	105130		
#8 x 1/2" .....	#6 .....	105140		110020
#8 x 1/2" .....	REG .....	105150		110030
#8 x 5/8" .....	#6 .....	105120		
#8 x 3/4" .....	#6 .....	105160		110040
#8 x 3/4" .....	REG .....	105170		110050
#8 x 1" .....	#6 .....	105180		110060
#8 x 1" .....	REG .....	105200		110070
#8 x 1-1/4" .....	#6 .....	105210		110080
#8 x 1-1/4" .....	REG .....	105220		110010
#8 x 1-1/2" .....	#6 .....	105230		110090
#8 x 1-1/2" .....	REG .....	105240		110100
#8 x 1-3/4" .....	#6 .....	105250		
#8 x 2" .....	#6 .....		105260	
#8 x 2" .....	REG .....		105270	
#8 x 2-1/2" .....	#6 .....		105280	
#8 x 2-5/8" .....	#6 .....	105290 (50)		
#10 x 1/2" .....	#6 .....	105310		
#10 x 1/2" .....	#8 .....	105320		110120
#10 x 1/2" .....	REG .....	105330		110110
#10 x 5/8" .....	#8 .....	105340		
#10 x 3/4" .....	#6 .....	105360		
#10 x 3/4" .....	#8 .....	105350		110130
#10 x 3/4" .....	REG .....			110180
#10 x 1" .....	#6 .....	105370		
#10 x 1" .....	#8 .....	105380		110150
#10 x 1" .....	REG .....	105390		110140
#10 x 1-1/4" .....	#8 .....	105410		110160
#10 x 1-1/4" .....	REG .....	105420		
#10 x 1-1/2" .....	#6 .....	105430		
#10 x 1-1/2" .....	#8 .....			110170
#10 x 1-3/4" .....	#8 .....		105450	
#10 x 1-3/4" .....	REG .....		105440	
#12 x 3/4" .....	REG .....		105470	
#12 x 1" .....	#10 .....		105480	

General Fasteners

# TAPPING SCREWS

## TAPPING SCREWS PHILLIPS PAN HEAD



100 Per Box  
Unless Otherwise  
Noted In Parenthesis

SIZE	ZINC CHROMATE	BLACK OXIDE
#4 x 1/4" .....	115010 .....	
#4 x 3/8" .....	115020 .....	
#4 x 1/2" .....	115030 .....	
#6 x 1/4" .....	115040 .....	
#6 x 3/8" .....	115050 .....	
#6 x 1/2" .....	115060 .....	120002
#6 x 3/4" .....	115070 .....	120004
#6 x 1" .....	115080 .....	120005
#6 x 1-1/4" .....	115085 .....	120006
#6 x 1-1/2" .....	115090 .....	
#8 x 1/4" .....	115100 .....	
#8 x 3/8" .....	115110 .....	
#8 x 1/2" .....	115120 .....	120010
#8 x 5/8" .....	115140 .....	
#8 x 3/4" .....	115150 .....	120020
#8 x 1" .....	115160 .....	120030
#8 x 1-1/4" .....	115170 .....	120040
#8 x 1-1/2" .....	115180 .....	
#10 x 3/8" .....	115200 .....	
#10 x 1/2" .....	115210 .....	120050
#10 x 5/8" .....	115220 .....	120055
#10 x 3/4" .....	115220 .....	120060
#10 x 1" .....	115230 .....	120070 (50)
#10 x 1-1/4" .....	115240 .....	120080 (50)
#10 x 1-1/2" .....	115250 .....	
#10 x 2" .....	115255 .....	
#12 x 1/2" .....	115260 .....	
#12 x 5/8" .....	115270 .....	
#12 x 3/4" .....	115280 .....	
#12 x 1" .....	115290 .....	
#12 x 1-1/4" .....	115295 .....	
#12 x 1-1/2" .....	115300 .....	
#14 x 1/2" .....	115310 .....	
#14 x 3/4" .....	115340 .....	
#14 x 1" .....	115360 .....	
#14 x 1-1/4" .....	115370 .....	
#14 x 1-1/2" .....	115380 .....	

# TAPPING SCREWS

## HEX HEAD TAPPING SCREWS NO WASHER ZINC PLATED

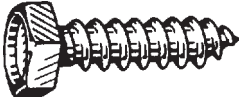

SIZE x LENGTH	HEAD SIZE	PRODUCT NO.
#10 x 1" .....	5/16" .....	<b>163080</b> (100)
#10 x 1-1/2" .....	5/16" .....	<b>163070</b> (100)
#12 x 1" .....	5/16" .....	<b>163110</b> (100)
#14 x 3/4" .....	7/16" .....	<b>163015</b> (100)
#14 x 1-1/2" .....	7/16" .....	<b>163130</b> (100)
5/16" x 3/4" .....	1/2" .....	<b>163020</b> (50)

Box Qty. In Parenthesis

## SELF DRILLING SCREWS HARDENED ZINC PLATED



SIZE x LENGTH	HEX WASHER HEAD	PHILLIPS PAN HEAD
#8 x 1/2" .....	<b>165010</b> (100) .....	<b>160010</b> (100)
#8 x 3/4" .....	<b>165020</b> (100) .....	<b>160020</b> (100)
#8 x 1" .....	<b>165030</b> (100) .....	<b>160025</b> (100)
#10 x 1/2" .....	<b>165040</b> (100) .....	<b>160030</b> (100)
#10 x 3/4" .....	<b>165050</b> (100) .....	<b>160040</b> (100)
#10 x 1" .....	<b>165060</b> (100) .....	<b>160050</b> (100)
#14 x 3/4" .....	<b>165070</b> (100) .....	N/A
#14 x 1" .....	<b>165080</b> (100) .....	N/A
#14 x 1-1/2" .....	<b>165090</b> (100) .....	N/A

Box Qty. In Parenthesis

## PHILLIPS OVAL HEAD SEMS TEK FINISHING SCREW (With No. 2 Drill Point)



Countersunk



Flush

SIZE	WASHER TYPE*	CHROME	BLACK PHOSPHATE	BOX QTY.
#8 x 5/8" .....	FL .....	<b>137005</b> .....	<b>137030</b> .....	100
#8 x 5/8" .....	CS .....	<b>137010</b> .....	<b>137035</b> .....	100
#8 x 3/4" .....	CS .....	<b>137015</b> .....	<b>137040</b> .....	100
#8 x 1" .....	CS .....	<b>137020</b> .....	<b>137045</b> .....	50
#8 x 1-1/4" .....	CS .....	<b>137025</b> .....	<b>137050</b> .....	50

\* FL = Flush, CS = Countersunk

## PHILLIPS ROUND WASHER HEAD TAPPING SCREW

TYPE "AB"  
1/2" DIA. WASHER HEAD  
PHOSPHATE AND OIL (BLACK)



PROD. NO.	SIZE	BOX QTY.
<b>200590</b> .....	#8-18 x 1/2" .....	100
<b>200591</b> .....	#8-18 x 3/4" .....	100
<b>200592</b> .....	#8-18 x 1" .....	100

General Fasteners

# TAPPING SCREWS

## PHILLIPS OVAL HEAD COUNTERSUNK WASHER TAPPING SCREWS

WASHER LOOSE FROM HEAD



SIZE x LENGTH	CHROME PLATED	BOX QTY.	BLACK PHOS	BOX QTY.
#6 x 5/8" .....	<b>135010</b> .....	100 .....		
#6 x 3/4" .....	<b>135020</b> .....	100 .....		
#6 x 1" .....	<b>135030</b> .....	100 .....		
#8 x 5/8" .....	<b>135040</b> .....	100 .....	<b>140010</b> .....	100
#8 x 3/4" .....	<b>135050</b> .....	100 .....	<b>140020</b> .....	100
#8 x 1" .....	<b>135060</b> .....	100 .....	<b>140040</b> .....	100
#8 x 1-1/4" .....	<b>135070</b> .....	50 .....	<b>140060</b> .....	100
#10 x 5/8" .....	<b>135080</b> .....	50 .....		
#10 x 3/4" .....	<b>135090</b> .....	50 .....	<b>140070</b> .....	50
#10 x 1" .....	<b>135100</b> .....	50 .....	<b>140080</b> .....	50
#10 x 1-1/4" .....	<b>135110</b> .....	50 .....		

General Fasteners

## PHILLIPS FLAT TOP WASHER HEAD TAPPING SCREWS

WASHER SOLID TO HEAD

**BLACK E-COAT**



## PHILLIPS OVAL HEAD FLUSH TYPE WASHER TAPPING SCREWS

WASHER LOOSE FROM HEAD



SIZE x LENGTH	PRODUCT NO.	BOX QTY.	PLATING
#8 x 5/8" .....	<b>136010</b> .....	50 .....	Chrome
#8 x 5/8" .....	<b>141010</b> .....	100 .....	Black
#8 x 11/16" .....	<b>141020</b> .....	100 .....	Black
#8 x 7/8" .....	<b>136020</b> .....	100 .....	Chrome
#8 x 1-1/4" .....	<b>141030</b> .....	100 .....	Black

SIZE x LENGTH	HEAD SIZE	PRODUCT NO.	BOX QTY.
#8 x 1/2" .....	7/16" .....	<b>200410</b> .....	100
#8 x 5/8" .....	7/16" .....	<b>200420</b> .....	100
#8 x 3/4" .....	7/16" .....	<b>200430</b> .....	100
#8 x 1" .....	7/16" .....	<b>200450</b> .....	100
#8 x 1" .....	1/2" .....	<b>200455</b> .....	100
#8 x 1-1/4" .....	7/16" .....	<b>200480</b> .....	100
#8 x 1-1/2" .....	7/16" .....	<b>200490</b> .....	50
#10 x 1/2" .....	7/16" .....	<b>200456</b> .....	100
#10 x 3/4" .....	15/32" .....	<b>200453</b> .....	100
#10 x 1" .....	1/2" .....	<b>200457</b> .....	100

# HEX HEAD SCREWS



## HEX WASHER HEAD SHEET METAL SCREWS

WASHER SOLID TO HEAD  
**ZINC CHROMATE**

SIZE	HEAD SIZE	PRODUCT NO.
#8 x 1/2" .....	1/4" .....	<b>146010</b> (100)
#8 x 1" .....	1/4" .....	<b>146030</b> (100)
#8 x 1-1/4" .....	1/4" .....	<b>146040</b> (100)
#8 x 1-1/2" .....	1/4" .....	<b>146050</b> (100)
#8 x 2" .....	1/4" .....	<b>146060</b> (100)
#10 x 1/2" .....	5/16" .....	<b>146070</b> (100)
#10 x 3/4" .....	5/16" .....	<b>146080</b> (100)
#10 x 1" .....	5/16" .....	<b>146090</b> (100)
#10 x 1-1/4" .....	5/16" .....	<b>146100</b> (100)
#10 x 1-1/2" .....	5/16" .....	<b>146110</b> (100)
#10 x 2" .....	5/16" .....	<b>146120</b> (100)
#12 x 3/4" .....	5/16" .....	<b>150050</b> (100)
#12 x 1" .....	5/16" .....	<b>150060</b> (100)
#12 x 1" .....	5/16" .....	<b>150060-1000</b> (1000)
#14 x 1/2" .....	3/8" .....	<b>150065</b> (100)
#14 x 3/4" .....	3/8" .....	<b>150070</b> (100)
#14 x 3/4" .....	3/8" .....	<b>150071</b> (500)
#14 x 1" .....	3/8" .....	<b>150090</b> (100)
#14 x 1-1/4" .....	3/8" .....	<b>150100</b> (50)
#14 x 1-1/2" .....	3/8" .....	<b>150110</b> (50)
5/16" x 3/4" .....	7/16" .....	<b>150010</b> (50)
5/16" x 1" .....	7/16" .....	<b>150020</b> (50)
5/16" x 1-1/2" .....	7/16" .....	<b>150030</b> (50)

**Box Qty. In Parenthesis**

## HEX WASHER HEAD SHEET METAL SCREW

WASHER LOOSE FROM HEAD  
**ZINC CHROMATE**



SIZE x LENGTH	HEAD SIZE	WASHER OD	PRODUCT NO.
#12 x 3/4" .....	7/16" .....	5/8" .....	<b>155030</b> (50)
#14 x 3/4" .....	3/8" .....	5/8" .....	<b>155071</b> (50)
#14 x 1" .....	3/8" .....	21/32" .....	<b>155080</b> (50)
#14 x 1-1/2" .....	7/16" .....	21/32" .....	<b>155120</b> (50)
5/16" x 1" .....	7/16" .....	11/16" .....	<b>155010</b> (50)
5/16" x 1-1/2" .....	7/16" .....	11/16" .....	<b>155020</b> (50)

**Box Qty. In Parenthesis**

# TORX DRIVE SCREWS

## TORX DRIVE SCREWS (STAINLESS STEEL)

RUST RESISTANT  
Meets OEM Specifications



### TORX OVAL HEAD SCREWS TRIM HEAD

METRIC SIZE	FINISH	PRODUCT NO.
4.2mm x 20mm	CHROME	<b>170080</b> (50)
4.2mm x 20mm	BLACK	<b>170090</b> (50)
4.2mm x 30mm	CHROME	<b>170110</b> (50)
4.2mm x 30mm	BLACK	<b>170120</b> (50)
4.2mm x 35mm	BLACK	<b>170135</b> (50)
4.2mm x 40mm	CHROME	<b>170040</b> (50)
4.2mm x 55mm	CHROME	<b>170020</b> (50)

**Box Qty. In Parenthesis**

### TORX PAN HEAD SCREWS

METRIC SIZE	FINISH	PRODUCT NO.
4.2mm x 20mm	CHROME	<b>175020</b> (50)
4.2mm x 20mm	BLACK	<b>175040</b> (50)

**Box Qty. In Parenthesis**

General Fasteners

## TORX DRIVE SCREWS (HARDENED STEEL)



### TORX OVAL HEAD SCREWS

METRIC SIZE	FINISH	PRODUCT NO.
4.2mm x 16mm	CHROME	<b>170060</b> (50)
4.2mm x 16mm	BLACK	<b>170070</b> (50)
4.2mm x 20mm	CHROME	<b>170081</b> (50)
4.2mm x 25mm	CHROME	<b>170100</b> (50)
4.2mm x 30mm	CHROME	<b>170111</b> (50)
4.2mm x 30mm	BLACK	<b>170121</b> (50)
4.2mm x 35mm	CHROME	<b>170130</b> (50)
4.2mm x 60mm	CHROME	<b>170140</b> (50)
4.2mm x 70mm	BLACK	<b>170160</b> (50)

**Box Qty. In Parenthesis**

### TORX PAN HEAD SCREWS

METRIC SIZE	FINISH	PRODUCT NO.
4.2mm x 13mm	CHROME	<b>175030</b> (50)
4.2mm x 20mm	BLACK	<b>170095</b> (50)
4.2mm x 25mm	CHROME	<b>175050</b> (50)
4.2mm x 25mm	BLACK	<b>175060</b> (50)
4.2mm x 55mm	CHROME	<b>175090</b> (50)

**Box Qty. In Parenthesis**

# MACHINE SCREWS

## SLOTTED ROUND HEAD MACHINE SCREWS ZINC PLATED STEEL



SIZE	PRODUCT NO. BOX 100
6-32 x 1/2" .....	180050
6-32 x 3/4" .....	180060
6-32 x 1" .....	180070
6-32 x 1-1/2" .....	180080
8-32 x 3/8" .....	180090
8-32 x 1/2" .....	180100
8-32 x 3/4" .....	180110
8-32 x 1" .....	180120
8-32 x 1-1/4" .....	180130
8-32 x 1-1/2" .....	180140
10-32 x 3/8" .....	180150
10-32 x 1/2" .....	180160
10-32 x 3/4" .....	180180
10-32 x 1" .....	180200
10-32 x 1-1/4" .....	180220
10-32 x 1-1/2" .....	180240
10-32 x 2" .....	180270
10-24 x 1/2" .....	180170
10-24 x 3/4" .....	180190
10-24 x 1" .....	180210
10-24 x 1-1/4" .....	180230
10-24 x 1-1/2" .....	180250
10-24 x 2" .....	180280
12-24 x 1/2" .....	180290
12-24 x 3/4" .....	180300
12-24 x 1" .....	180310
12-24 x 1-1/2" .....	180320
1/4-20 x 1/2" .....	180010
1/4-20 x 3/4" .....	180020
1/4-20 x 1" .....	180030
1/4-20 x 1-1/2" .....	180035
1/4-20 x 2" .....	180040















## PHILLIPS OVAL HEAD MACHINE SCREWS CHROME PLATED STEEL

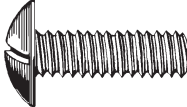

SIZE	HEAD SIZE	PROD. NO. BOX 100
8-32 x 1/2" .....	STD .....	190020
8-32 x 3/4" .....	#6 .....	190030
10-24 x 1/2" .....	STD .....	190060
10-24 x 3/4" .....	STD .....	190080
10-32 x 1" .....	#8 .....	190090

# LICENSE SCREWS - NUTS AND OTHER FASTENERS

General Fasteners

 <p><b>85255</b> Stainless Steel #14 x 3/4" Phillips Truss Head Box Qty. 50</p>	<p>125261 Box 500</p>  <p><b>125260</b> Zinc #14 x 3/4" Slotted Truss Head Head Dia.: 9/16" Box Qty. 100</p>	 <p><b>125265</b> Zinc Plated #14 x 3/4" Slotted Pan Head Sheet Metal Screw Box Qty. 100</p>	<p>150071 Box 500</p>  <p><b>150070</b> Zinc #14 x 3/4" Slotted Hex Washer Head Hex: 3/8" Ford &amp; GM Box Qty. 100</p>
 <p><b>150075</b> Black E-Coat (168 Hours Salt Spray) #14 x 3/4" Slotted Hex Washer Head Hex: 3/8" Washer Head O.D.: 1/2" Ford Box Qty. 50</p>	 <p><b>200025</b> 3783002 Zinc #14 x 1/2" Total Length: 1-1/8" Dealer License Plate Thumb Screw Box Qty. 25</p>	 <p><b>200030</b> 3783002 Zinc #10 x 5/8" Slotted Truss Washer Head Washer Head O.D.: 1/2" GM Box Qty. 100</p>	 <p><b>200192</b> 9420052, 11502483, 11503503 Chrome M4.2-1.41 x 20mm (#8 x 25/32") Phillips Pan Head Sems Pozi-Drive Washer O.D.: 12mm (1/2") GM Box Qty. 50</p>
 <p><b>200225</b> Nylon Screw, Spacer, Washer And Brass Nut License Attachment Kit M6-1.0 x 20mm Slotted Pan Head 12.5mm Washer Import Cars Box Qty. 25 Sets</p>	 <p><b>200230</b> Zinc Plated 1/4-20 x 1/2" Slotted Truss Head Machine Screw Box Qty. 100</p>	 <p><b>200231</b> Zinc &amp; Clear M6-1.0 x 16mm Hex Flange License Plate Screw Flange O.D.: 14mm (9/16") Hex: 10mm Class 10.9 Acura Box Qty. 50</p>	 <p><b>200233</b> Black Zinc M6-1.0 x 20mm Phillips Pan Head Import Vehicles &amp; General Use Box Qty. 50</p>
 <p><b>200235</b> Bright Zinc 1/4-20 x 1/2" Slotted Fillister Head Machine Screw Box Qty. 100</p>	 <p><b>200402</b> N800369 Bright Zinc #14 (1/4") x 5/8" Washer Dia.: 5/8" Hex A/F: 5/16" Slotted Indented Hex Head Ford Box Qty. 50</p>	<p>200403-1M Box 1000</p>  <p><b>200403</b> N800369-S2 Black E-Coat #14 (1/4") x 5/8" Washer Dia.: 5/8" Hex A/F: 5/16" Slotted Hex Washer Head Ford Box Qty. 50</p>	 <p><b>200404</b> Zinc #14 x 3/4" Slotted Truss Head Type B Screw, Blunt Point Head Dia.: 9/16" Box Qty. 100</p>

# LICENSE SCREWS - NUTS AND OTHER FASTENERS



**200453**  
 Black E-Coat  
 (168 Hours Salt Spray)  
 #10 x 3/4"  
 Phillips Flat Washer Head  
 License Plate Screw  
 & General Purpose  
 15/32" Washer Hd. O.D.  
 Box Qty. 100



**200615**  
 Black E Coat  
 (168 Hours Salt Spray)  
 #14 x 3/4"  
 Slotted Truss Head  
 License Plate Screw  
 Head Dia.: 9/16"  
 Box Qty. 100



**235030**  
 Zinc Chromate Plated  
 Hardened Steel  
 1/4-20 Thread Size  
 Flanged Spin Lock Nut  
 General Purpose  
 Box Qty. 100



**280045**  
 Nylon  
 #8 Screw Size  
 License Plate Nut  
 Chrysler Products  
 Box Qty. 100

**280131** Box 500



**280130**  
 Nylon  
 Split Two Ways  
 Under Head  
 Ford '65 - UP  
 General Purpose  
 Box Qty. 100

**280136** Box 500



**280135**  
 3907444, 4755299  
 Nylon  
 License Plate Nut  
 Split Four Ways  
 Under Head  
 #14 (1/4") Screw Size  
 GM  
 Box Qty. 100



**290100**  
 6032516  
 Nylon  
 License Plate Nut  
 #12 Screw Size  
 Chrysler  
 Box Qty. 25



**292010**  
 1747001  
 Nylon  
 License Plate Nut  
 American Motors Cars  
 Box Qty. 100

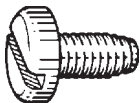

**890610**  
 Zinc Plated Steel  
 M6-1.00 x 10mm  
 Slotted Pan Head  
 Machine Screw  
 Box Qty. 50

**890616-500** Box 500

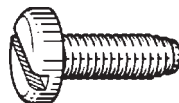

**890616**  
 Zinc Plated Steel  
 M6-1.00 x 16mm  
 Slotted Pan Head  
 Machine Screw  
 Box Qty. 50

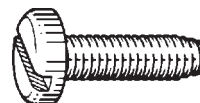

**890620**  
 Zinc Plated Steel  
 M6-1.00 x 20mm  
 Slotted Pan Head  
 Machine Screw  
 Box Qty. 50



**897510**  
 Zinc Plated Steel  
 M5-0.8 x 10mm  
 Phillips Pan Head  
 Import Cars  
 Box Qty. 100



**897610**  
 Zinc Plated Steel  
 M6-1.0 x 10mm  
 Phillips Pan Head  
 Import & Domestic Cars  
 Box Qty. 50



**897612**  
 Zinc Plated Steel  
 M6-1.0 x 12mm  
 Phillips Pan Head  
 Import & Domestic Cars  
 Box Qty. 50



**897616**  
 Zinc Plated Steel  
 M6-1.0 x 16mm  
 Phillips Pan Head  
 Import & Domestic Cars  
 Box Qty. 50

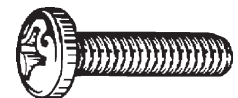

**897620**  
 Zinc Plated Steel  
 M6-1.0 x 20mm  
 Phillips Pan Head  
 Import & Domestic Cars  
 Box Qty. 50

General Fasteners

# GRADE 5 CAP SCREW

## CAP SCREWS GRADE 5

ZINC PLATED

120,000 P.S.I. Minimum  
Tensile Strength

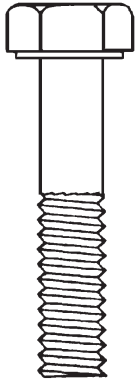

**1/4"**  
**DIA.**

1/4"-20  
USS (Coarse)

1/4"-28  
SAE (Fine)

LENGTH	USS (Coarse)		SAE (Fine)	
	PROD. #	QTY.	PROD. #	QTY.
1/2"	205030	100	210010	100
3/4"	205050	100	210020	100
1"	205060	100	210030	100
1-1/4"	205070	100	210040	100
1-1/2"	205080	100	210050	100
1-3/4"	205090	100	210060	100
2"	205100	100	210070	50
2-1/4"	205110	50	210075	50
2-1/2"	205120	50	210080	50
2-3/4"	205130	50	210082	50
3"	205140	50	210084	50
3-1/2"	205150	50	210086	50
4"	205152	25	*	
4-1/2"	205154	25	*	
5"	205156	25	*	
6"	205158	25	*	

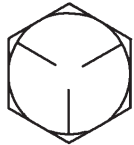

**5/16"**  
**DIA.**

5/16"-18  
USS (Coarse)

5/16"-24  
SAE (Fine)

1/2"	205160	100	210090	100
3/4"	205170	100	210100	100
1"	205180	100	210110	100
1-1/4"	205190	50	210120	50
1-1/2"	205200	50	210130	50
1-3/4"	205210	50	210140	50
2"	205220	50	210150	50
2-1/4"	205230	50	210155	50
2-1/2"	205240	50	210160	50
2-3/4"	*	50	210165	50
3"	205250	25	210170	50
3-1/4"	205260	25	210175	50
3-1/2"	205270	25	210180	50
4"	205280	25	210185	50
4-1/2"	205282	25	*	
5"	205284	25	*	
5-1/2"	205286	25	*	
6"	205288	25	*	
7"	205290	25	*	

\*NOT A STOCK ITEM

# GRADE 5 CAP SCREW

LENGTH	USS (Coarse) PROD. #	QTY.	SAE (Fine) PROD. #	QTY.
3/4"	205300	50	210190	50
1"	205310	50	210200	50
1-1/4"	205320	50	210210	50
1-1/2"	205330	50	210220	25
1-3/4"	205340	25	210225	25
2"	205350	25	210230	25
2-1/4"	205360	25	210235	25
2-1/2"	205370	25	210240	25
2-3/4"	*		*	
3"	205380	25	210241	25
3-1/2"	205390	25	210242	25
4"	205400	25	210244	25
4-1/2"	205405	25	210245	25
5"	205410	25	210247	25
5-1/2"	205412	25	210248	25
6"	205414	25	210249	25

3/4"	205420	25	210250	50
1"	205430	25	210260	25
1-1/4"	205440	25	210270	25
1-1/2"	205450	25	210280	25
1-3/4"	205460	25	210285	25
2"	205470	25	210290	25
2-1/4"	*		*	
2-1/2"	205480	25	210291	25
2-3/4"	205485		*	
3"	205490	25	210293	25
3-1/4"	*		*	
3-1/2"	205500	25	210294	25
4"	205510		210295	25
4-1/2"	205515	25	210296	25
5"	205520	25	210297	25
5-1/2"	205522	25	210298	25
6"	205524	25	210299	25

## CAP SCREWS GRADE 5 ZINC PLATED

120,000 P.S.I. Minimum  
Tensile Strength

### 3/8" DIA.

3/8"-16  
USS (Coarse)

3/8"-24  
SAE (Fine)

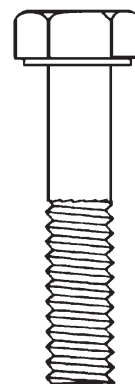

### 7/16" DIA.

7/16"-14  
USS (Coarse)

7/16"-20  
SAE (Fine)

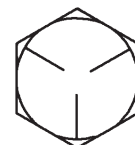

\* NOT A STOCK ITEM

# GRADE 5 CAP SCREW

## CAP SCREWS GRADE 5

ZINC PLATED

120,000 P.S.I. Minimum  
Tensile Strength

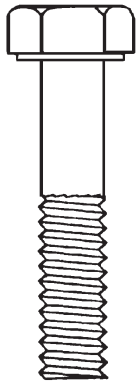

**1/2"**  
**DIA.**

1/2"-13  
USS (Coarse)

1/2"-20  
SAE (Fine)

LENGTH	USS (Coarse) PROD. #	QTY.	SAE (Fine) PROD. #	QTY.
3/4"	205530	25	210300	25
1"	205540	25	210310	25
1-1/4"	205550	25	210320	25
1-1/2"	205560	25	210330	25
1-3/4"	205570	25	210340	25
2"	205580	25	210350	25
2-1/4"	205585*		*	
2-1/2"	205590	25	210352	25
2-3/4"	*		*	
3"	205600	25	210354	25
3-1/4"	*		*	
3-1/2"	205610	25	210356	25
3-3/4"	*		*	
4"	205620	10	210358	25
4-1/2"	205625	10	210360	25
5"	205630	10	210362	25
5-1/2"	205632	10	210364	25
6"	205634	10	210366	25

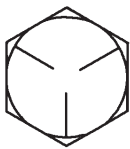

**5/8"**  
**DIA.**

5/8"-11  
USS (Coarse)

5/8"-18  
SAE (Fine)

1"	205700	10	210400	10
1-1/4"	*		*	
1-1/2"	205710	10	210410	10
1-3/4"	*		*	
2"	205720	10	210420	10
2-1/4"	*		*	
2-1/2"	205730	10	210430	10
3"	205740	10	210440	10
3-1/2"	205750	10	210450	10
4"	205760	10	210460	10
4-1/2"	205770	10	210470	10
5"	205780	10	210480	10
6"	205790	10	210500	10

**3/4"**  
**DIA.**

3/4"-10  
USS (Coarse)

3/4"-16  
SAE (Fine)

1"	205799	10	210510	10
1-1/4"	*		*	
1-1/2"	205800	10	210520	10
1-3/4"	*		*	10
2"	205810	10	210530	10
2-1/2"	205820	10	210540	10
3"	205830	10	210550	10
3-1/2"	205840	10	210560	10
3-3/4"	*		*	
4"	205850	10	210570	10
4-1/2"	205860	10	210580	10
5"	205870	10	210590	10
5-1/2"	205880	10	210600	10
6"	205890	10	210610	10

\* NOT A STOCK ITEM

# GRADE 8 CAP SCREW

LENGTH	USS (Coarse)		SAE (Fine)	
	PROD. #	QTY.	PROD. #	QTY.
1/2"	810100	50	820100	50
3/4"	810101	50	820101	50
1"	810102	50	820102	50
1-1/4"	810103	50	820103	50
1-1/2"	810104	50	820104	50
1-3/4"	810105	50	820105	50
2"	810106	50	820106	50
2-1/4"	810107	25	820107	25
2-1/2"	810108	25	820108	25
2-3/4"	810109	25	820109	25
3"	810110	25	820110	25
3-1/2"	*		*	

1/2"	810200	50	820200	50
3/4"	810201	50	820201	50
1"	810202	50	820202	50
1-1/4"	810203	50	820203	50
1-1/2"	810204	50	820204	50
1-3/4"	810205	50	820205	50
2"	810206	50	820206	50
2-1/4"	810207	25	820207	50
2-1/2"	810208	25	820208	25
2-3/4"	810209	25	820209	25
3"	810210	25	820210	25
3-1/4"	810211*	25	820211*	25
3-1/2"	810212*	25	820212*	25
4"	810213*	25	820213*	25

3/4"	810300	50	820300	50
1"	810301	50	820301	50
1-1/4"	810302	50	820302	50
1-1/2"	810303	50	820303	50
1-3/4"	810304	50	820304	50
2"	810305	50	820305	50
2-1/4"	810306	25	820306	25
2-1/2"	810307	25	820307	25
2-3/4"	810308	25	820308	25
3"	810309	25	820309	25
3-1/2"	810311	25	820311	25
4"	810313	25	820313	25
4-1/2"	*		*	
5"	*		*	
5-1/2"	*		*	
6"	*		*	

\* NOT A STOCK ITEM

## CAP SCREWS GRADE 8

YELLOW ZINC PLATED

150,000 P.S.I. Minimum  
Tensile Strength

**1/4"**  
**DIA.**

1/4"-20  
USS (Coarse)

1/4"-28  
SAE (Fine)

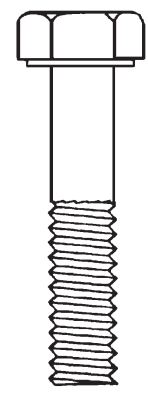

**5/16"**  
**DIA.**

5/16"-18  
USS (Coarse)

5/16"-24  
SAE (Fine)

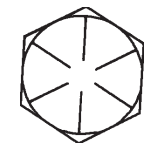

**3/8"**  
**DIA.**

3/8"-16  
USS (Coarse)

3/8"-24  
SAE (Fine)

# GRADE 8 CAP SCREW

## CAP SCREWS GRADE 8

YELLOW ZINC PLATED

150,000 P.S.I. Minimum  
Tensile Strength

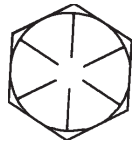
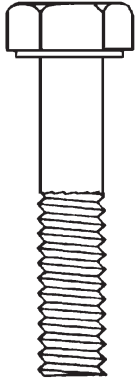

**7/16"**  
**DIA.**

**7/16"-14**  
**USS (Coarse)**

**7/16"-20**  
**SAE (Fine)**

**1/2"**  
**DIA.**

**1/2"-13**  
**USS (Coarse)**

**1/2"-20**  
**SAE (Fine)**

LENGTH	USS (Coarse) PROD. #	QTY.	SAE (Fine) PROD. #	QTY.
3/4"	810400	50	820400	25
1"	810401	50	820401	25
1-1/4"	810402	50	820402	25
1-1/2"	810403	50	820403	25
1-3/4"	810404	10	820404	10
2"	810405	10	820405	10
2-1/4"	810406	10	820406	10
2-1/2"	810407	10	820407	10
2-3/4"	810408	10	820408	10
3"	810409	10	820409	10
3-1/4"	810410	10	820410	10
3-1/2"	810411	10	820411	10
3-3/4"	810412	10	820412*	10
4"	810413	10	820413	10
4-1/2"	810415	10	820415	10
5"	810417	10	820417	10
5-1/2"	*		*	
6"	*		*	

3/4"	*		*	
1"	810500	25	820500	25
1-1/4"	810501	25	820501	25
1-1/2"	810502	25	820502	25
1-3/4"	810503	25	820503	25
2"	810504	25	820504	25
2-1/4"	810505	25	820505	25
2-1/2"	810506	25	820506	25
2-3/4"	810507	25	820507	25
3"	810508	25	820508	25
3-1/4"	810509	25	820509	10
3-1/2"	810510	10	820510	10
3-3/4"	810511	10	820511	10
4"	810512	10	820512	10
4-1/4"	810513*	10	820513*	10
4-1/2"	810514	10	820514	10
5"	810516	10	820516	10
5-1/2"	810517	10	820517	10
6"	810519	10	820519	10

\* NOT A STOCK ITEM

# GRADE 8 CAP SCREW

LENGTH	USS (Coarse) PROD. #	QTY.	SAE (Fine) PROD. #	QTY.
1"	810600	10	820600	10
1-1/4"	810601	10	820601	10
1-1/2"	810602	10	820602	10
1-3/4"	810603	10	820603	10
2"	810604	10	820604	10
2-1/4"	810605	10	820605	10
2-1/2"	*	10	820606	10
2-3/4"	810607	10	820607	10
3"	810608	10	820608	10
3-1/4"	810609	10	820609	10
3-1/2"	810610	10	820610	10
3-3/4"	810611*	10	820611*	10
4"	810612	10	820612	10
4-1/2"	810614	10	820614	10
5"	810616	10	820616	10
5-1/2"	810618	10	820618	10
6"	810620	10	820620	10

1"	810700	10	820700	10
1-1/4"	810701	10	820701	10
1-1/2"	810702	10	820702	10
1-3/4"	810703	10	820703	10
2"	810704	10	820704	10
2-1/4"	810705	10	820705	10
2-1/2"	810706	10	820706	10
2-3/4"	810707	10	820707*	10
3"	810708	10	820708	10
3-1/4"	810709	10	820709*	10
3-1/2"	810710	10	820710	10
4"	810712	10	820712	10
4-1/2"	810714	10	820714	10
5"	810716	10	820716	10
6"	810718	10	820718	10

1"	*		*	
1-1/4"	*	10	820800	10
1-1/2"	810801	10	820801	10
1-3/4"	810802	10	820802	10
2"	810803	10	820803	10
2-1/4"	810804	10	820804*	10
2-1/2"	810805	10	820805	10
2-3/4"	810806	10	820806*	10
3"	810807	10	820807	10
3-1/4"	810808	10	820808*	10
3-1/2"	810809	10	820809	10
3-3/4"	810810	10	820810	10
4"	810811	10	820811	10
4-1/2"	810813	10	820813	10
5"	810815	10	820815	10
5-1/2"	810816	10	820816	10
6"	810817	10	820817	10

## CAP SCREWS GRADE 8

YELLOW ZINC PLATED

150,000 P.S.I. Minimum  
Tensile Strength

**9/16"**  
**DIA.**

9/16"-12  
USS (Coarse)

9/16"-18  
SAE (Fine)

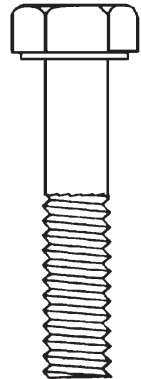

**5/8"**  
**DIA.**

5/8"-11  
USS (Coarse)

5/8"-18  
SAE (Fine)

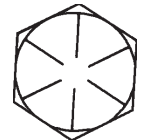

**3/4"**  
**DIA.**

3/4"-10  
USS (Coarse)

3/4"-16  
SAE (Fine)

\*NOT A STOCK ITEM

# FRAME MACHINE FASTENERS

General Fasteners

## GRADE 8 HARDENED BOLTS & KITS

SIZE	BOLT ONLY PROD. # PKG. QTY.	BOLT, WASHER & NUT KIT PROD. #
1/2-13 x 2" .....	<b>810504</b> ..... 25	<b>610504*</b>
1/2-13 x 2-1/2" .....	<b>810506</b> ..... 25	<b>610506*</b>
1/2-13 x 3" .....	<b>810508</b> ..... 25	<b>610508*</b>
1/2-13 x 3-1/2" .....	<b>810510</b> ..... 10	<b>610510*</b>
5/8-11 x 2" .....	<b>810704</b> ..... 10	<b>610704*</b>
5/8-11 x 2-1/2" .....	<b>810706</b> ..... 10	<b>610706*</b>
5/8-11 x 3" .....	<b>810708</b> ..... 10	<b>610708*</b>
5/8-11 x 3-1/2" .....	<b>810710</b> ..... 10	<b>610710*</b>
5/8-11 x 4" .....	<b>810712</b> ..... 10	<b>610712*</b>
3/4-10 x 5" .....	<b>810815</b> ..... 10	<b>610815*</b>

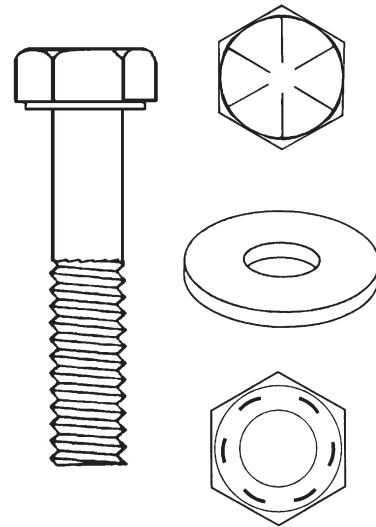

\* Each Kit contains 10 bolts, 20 SAE washers and 10 nuts except for kit # 610815 which contains 4 bolts, 8 SAE washers and 4 nuts.

## GRADE 8 HEX NUTS

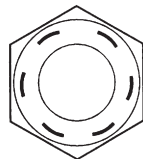

SIZE	PROD. #	BOX QTY.
1/2-13 .....	<b>830104</b> .....	50
5/8-11 .....	<b>830106</b> .....	25
3/4-10 .....	<b>830107</b> .....	25

## GRADE 8 HEX HARDENED SAE FLAT WASHERS

BOLT SIZE	DIMENSIONS	PROD. #	BOX QTY.
1/2" ....	17/32" I.D. x 1-1/16" O.D. ....	<b>850104</b> .....	50
5/8" ....	21/32" I.D. x 1-5/16" O.D. ....	<b>850106</b> .....	25
3/4" ....	13/16" I.D. x 1-1/2" O.D. ....	<b>850107</b> .....	25

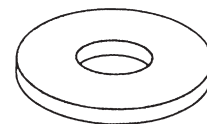

# HEX NUTS

## GRADE 5 - HEX NUTS STANDARD FINISHED BRIGHT ZINC PLATED

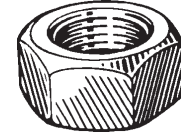

DIA. THREAD	HEX WIDTH	USS/ SAE	PROD. #	BOX QTY.
1/4"-20	7/16"	USS	225010	100
1/4"-28	7/16"	SAE	230010	100
5/16"-18	1/2"	USS	225020	100
5/16"-24	1/2"	SAE	230020	100
3/8"-16	9/16"	USS	225030	100
3/8"-24	9/16"	SAE	230030	100
7/16"-14	11/16"	USS	225040	100
7/16"-20	11/16"	SAE	230040	100
1/2"-13	3/4"	USS	225050	100
1/2"-20	3/4"	SAE	230050	100
9/16"-12	7/8"	USS	225060	50
9/16"-18	7/8"	SAE	230060	50
5/8"-11	15/16"	USS	225070	50
5/8"-18	15/16"	SAE	230070	50
3/4"-10	1-1/8"	USS	225076	25
3/4"-16	1-1/8"	SAE	230080	50

## HARDENED - GRADE 8 FINISHED HEX NUTS YELLOW ZINC PLATED



DIA. THREAD	HEX WIDTH	USS/ SAE	PROD. #	BOX QTY.
1/4"-20	7/16"	USS	830100	50
1/4"-28	7/16"	SAE	840100	50
5/16"-18	1/2"	USS	830101	50
5/16"-24	1/2"	SAE	840101	50
3/8"-16	9/16"	USS	830102	50
3/8"-24	9/16"	SAE	840102	50
7/16"-14	11/16"	USS	830103	50
7/16"-20	11/16"	SAE	840103	50
1/2"-13	3/4"	USS	830104	50
1/2"-20	3/4"	SAE	840104	50
9/16"-12	7/8"	USS	830105	25
9/16"-18	7/8"	SAE	840105	25
5/8"-11	15/16"	USS	830106	25
5/8"-18	15/16"	SAE	840106	25
3/4"-10	1-1/8"	USS	830107	25

# NUTS, MISC

## MACHINE SCREW HEX NUTS ZINC PLATED



PRODUCT NUMBER	THREAD SIZE	HEX WIDTH	BOX QTY.
225080	6-32	5/16"	100
225090	8-32	5/16"	100
225100	10-24	3/8"	100
225110	10-32	3/8"	100
225120	12-24	7/16"	100

## HARDENED FLANGED LOCK NUTS (SERRATED) ZINC PLATED



PROD. NO.	DESCRIPTION	BOX QTY.
235020	8-32 SAE	50
235080	10-24 USS	100
235030	1/4-20 USS	100
235035	1/4-28 SAE	100
235060	5/16-18 USS	50
235065	5/16-24 SAE	50
235070	3/8-16 USS	50
235075	3/8-24 SAE	50
235010	7/16-14 USS	25
235015	7/16-20 SAE	25

## NYLON INSERTED LOCK NUTS ZINC PLATED

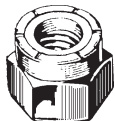

PROD. NO.	DESCRIPTION	BOX QTY.
260003	8-32	100
260004	10-24 USS	100
261004	10-32 SAE	100
260005	1/4-20 USS	100
261005	1/4-28 SAE	100
260010	5/16-18 USS	50
261010	5/16-24 SAE	50
260020	3/8-16 USS	50
261020	3/8-24 SAE	50
260030	7/16-14 USS	50
261030	7/16-20 SAE	50
260040	1/2-13 USS	50
261040	1/2-20 SAE	50
260050	5/8-11 USS	50
261050	5/8-18 SAE	50
260060	3/4-10 USS	50
261060	3/4-16 SAE	50

## WING NUTS ZINC PLATED



PROD. NO.	DESCRIPTION	BOX QTY.
303190	10-24	100
303200	1/4-20	50

# WASHERS

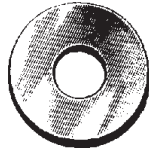

## STANDARD USS FLAT WASHERS ZINC CHROMATE HIGH STRENGTH USS FLAT WASHERS

**YELLOW ZINC**  
R/C 38-45 HARDNESS

BOLT SIZE	INSIDE DIA.	OUTSIDE DIA.	STANDARD PROD. #	BOX QTY.	HIGH STRENGTH PROD. #	BOX QTY.
#10 or 3/16"	1/4"	9/16"	310010	100		
1/4"	5/16"	3/4"	310020	100	855100	100
5/16"	3/8"	7/8"	310030	100	855101	100
3/8"	7/16"	1"	310040	100	855102	100
7/16"	1/2"	1-1/4"	310050	100	855103	50
1/2"	9/16"	1-3/8"	310060	100	855104	50
9/16"	5/8"	1-1/2"	310070	100	855105	25
5/8"	11-16"	1-3/4"	310080	50	855106	25
3/4"	13/16"	2"	310090	50	855107	25

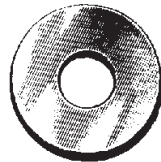

## STANDARD SAE FLAT WASHERS ZINC CHROMATE GRADE 8 HARDNESS WASHERS YELLOW ZINC

BOLT SIZE	INSIDE DIAMETER	OUTSIDE DIAMETER	STANDARD PRODUCT #	BOX QTY.	GRADE 8 PRODUCT #	BOX QTY.
#6 or 1/8"	5/32"	3/8"	311005	100		
#10 or 3/16"	7/32"	1/2"	311007	100		
1/4"	9/32"	5/8"	311010	100	850100	100
5/16"	11/32"	11/16"	311020	100	850101	100
3/8"	13/32"	13/16"	311030	100	850102	100
7/16"	15/32"	15/16"	311040	100	850103	50
1/2"	17/32"	1-1/16"	311050	100	850104	50
9/16"	19/32"	1-3/16"			850105	50
5/8"	21/32"	1-5/16"	311060	100	850106	25

PRODUCT NUMBER	BOLT SIZE	OUTSIDE DIAMETER	BOX QTY.
312010	#10 or 3/16"	1"	100
312020	1/4"	1-1/4"	100
312030	5/16"	1-1/4"	100
312040	3/8"	1-1/2"	100

## FENDER WASHERS ZINC CHROMATE

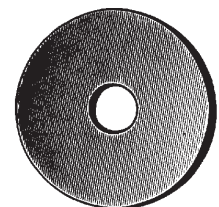

# WASHERS

## STANDARD SPRING TYPE LOCK WASHER

Grade 5  
ZINC CHROMATE



PRODUCT NUMBER	SIZE	BOX QTY.
315090	#6 or 1/8"	200
315100	#8 or 5/32"	200
315110	#10 or 3/16"	200
315010	1/4"	200
315020	5/16"	200
315030	3/8"	200
315040	7/16"	200
315050	1/2"	200
315060	9/16"	100
315070	5/8"	100
315080	3/4"	50

## HIGH ALLOY SPRING TYPE LOCK WASHERS

Grade 8  
ZINC & YELLOW DICHROMATE



PART NUMBER	BOLT SIZE	UNIT PKG.
316010	1/4"	100
316020	5/16"	100
316030	3/8"	100
316040	7/16"	50
316050	1/2"	50
316060	9/16"	50
316070	5/8"	50
316080	3/4"	25
316090	7/8"	25
316100	1"	25

General Fasteners

## EXTERNAL AND INTERNAL LOCK WASHERS

ZINC CHROMATE



INTERNAL  
TYPE

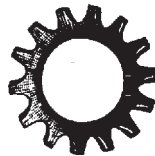

EXTERNAL  
TYPE

SCREW SIZE	EXTERNAL PRODUCT NO.	INTERNAL PRODUCT NO.
#4	325040	320010
#6	325050	320020
#8	325060	320030
#10	325070	320040
#12	325080	320050
1/4"	325010	320060
5/16"	325020	320070
3/8"	325030	320080

## TRIM WASHERS

NICKEL ON BRASS



COUNTERSUNK TYPE



FLANGED TYPE



FLUSH TYPE

SIZE	COUNTERSUNK PROD. NO.	FLANGED PROD. NO.	FLUSH PROD. NO.	BOX QTY.
No. 4	330030			100
No. 6	330040	330050	330005	100
No. 8	330070	330080	330006	100
No. 10	330110	330120		100
No. 14	330130			100

# STAINLESS STEEL FASTENERS

## LOCK WASHERS

STAINLESS STEEL 18-8



PRODUCT NUMBER	SIZE	BOX QTY.
85140	# 8	200
85141	#10	200
85142	1/4"	100
85143	5/16"	100
85144	3/8"	50
85145	7/16"	25
85146	1/2"	25

## FLAT WASHERS

STAINLESS STEEL 18-8

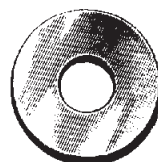

PRODUCT NUMBER	SIZE	BOX QTY.
85120	# 8	100
85121	#10	50
85122	1/4"	50
85123	5/16"	50
85124	3/8"	50
85125	7/16"	25
85126	1/2"	20

## HEX NUTS

STAINLESS STEEL 18-8



PRODUCT NUMBER	SIZE	BOX QTY.
85100	4-40	50
85101	6-32	50
85102	8-32	50
85103	10-24	50
85104	10-32	50
85105	12-24	50
85106	1/4-20	50
85108	5/16-18	25
85110	3/8-16	20
85112	7/16-14	10
85114	1/2-13	10

## CAP SCREWS

STAINLESS STEEL 18-8

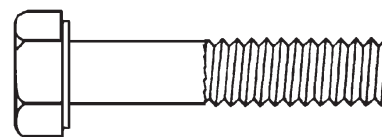

PROD. NO.	DESCRIPTION	BOX
85001	1/4-20 x 1/2"	25
85002	1/4-20 x 3/4"	25
85003	1/4-20 x 1"	25
85004	1/4-20 x 1-1/4"	20
85005	1/4-20 x 1-1/2"	20
85006	1/4-20 x 1-3/4"	15
85007	1/4-20 x 2"	10
85008	1/4-20 x 2-1/4"	10
85009	1/4-20 x 2-1/2"	10
85020	5/16-18 x 1/2"	20
85021	5/16-18 x 3/4"	20
85022	5/16-18 x 1"	15
85023	5/16-18 x 1-1/4"	15
85024	5/16-18 x 1-1/2"	10
85025	5/16-18 x 1-3/4"	10
85026	5/16-18 x 2"	10
85027	5/16-18 x 2-1/4"	10
85028	5/16-18 x 2-1/2"	10
85030	5/16-18 x 3"	10
85095	3/8-16 x 5/8"	100
85040	3/8-16 x 3/4"	10
85041	3/8-16 x 1"	10
85042	3/8-16 x 1-1/4"	10
85043	3/8-16 x 1-1/2"	10
85044	3/8-16 x 1-3/4"	10
85045	3/8-16 x 2"	10
85046	3/8-16 x 2-1/4"	10
85047	3/8-16 x 2-1/2"	10
85060	7/16-14 x 3/4"	10
85061	7/16-14 x 1"	10
85062	7/16-14 x 1-1/4"	10
85063	7/16-14 x 1-1/2"	10
85067	7/16-14 x 2-1/2"	5
85080	1/2-13 x 1"	5
85081	1/2-13 x 1-1/4"	5
85082	1/2-13 x 1-1/2"	5
85083	1/2-13 x 1-3/4"	5
85084	1/2-13 x 2"	5
85085	1/2-13 x 2-1/2"	5
85087	1/2-13 x 3"	5

# STAINLESS STEEL FASTENERS

## MACHINE SCREWS 18-8



**SLOTTED  
ROUND HEAD**



**PHILLIPS  
OVAL**

SIZE	SLOTTED ROUND		PHILLIPS OVAL	
	PROD.#	BOX QTY.	PROD.#	BOX QTY.
8-32 x 1/2" .....	85150	50	85200	50
8-32 x 3/4" .....	85155	50	85201	50
8-32 x 1" .....	85156	50	85202	50
8-32 x 1-1/2" .....	85157	50	85204	50
10-24 x 1/2" .....	85160	50	85210	50
10-24 x 3/4" .....	85161	50	85211	50
10-24 x 1" .....	85162	25	85212	25
10-24 x 1-1/4" .....	85163	25		
10-24 x 1-1/2" .....	85164	25	85214	25
10-24 x 2" .....	85166	25	85216	20
10-32 x 1/2" .....	85170	50	85220	50
10-32 x 3/4" .....	85171	50	85221	50
10-32 x 1" .....	85172	25	85222	25
10-32 x 1-1/4" .....	85173	25		
10-32 x 1-1/2" .....	85174	25	85224	25
10-32 x 2" .....	85176	25		
1/4-20 x 1/2" .....	85180	25		
1/4-20 x 3/4" .....	85181	25	85230	25
1/4-20 x 1" .....	85182	20	85231	25
1/4-20 x 1-1/2" .....	85184	20	85232	25
1/4-20 x 1-3/4" .....			85233	15
1/4-20 x 2" .....	85186	10	85235	10

## TAPPING SCREWS 18-8



**PHILLIPS  
PAN HEAD**



**PHILLIPS  
OVAL**

SIZE	PHILLIPS PAN		PHILLIPS OVAL	
	PROD.#	BOX QTY.	PROD.#	BOX QTY.
# 6 x 1/2" .....			85300	50
# 6 x 3/4" .....			85301	50
# 6 x 1" .....			85302	50
# 6 x 1-1/4" .....			85303	50
# 8 x 1/2" .....	85240	50	85310	50
# 8 x 3/4" .....	85241	50	85311	50
# 8 x 1" .....	85242	50	85312	50
# 8 x 1-1/4" .....	85243	50	85313	25
# 8 x 1-1/2" .....	85244	25	85314	25
#10 x 1/2" .....	85250	50	85320	50
#10 x 3/4" .....	85251	50	85321	50
#10 x 1" .....	85252	25	85322	25
#10 x 1-1/4" .....	85253	25	85323	25
#10 x 1-1/2" .....	85254	25	85324	25
#14 x 3/4" TRUSS .....	85255	50		