

GM CLIPS & FASTENERS

27999 Box 25



28000

6031115, 9436175, 385189-S100
 Peel-Type Rivet
 Dia.: 1/4" Grip: 1/32" - 9/64"
 Flange Dia.: 1/2"
 Aluminum Rivet, Steel Mandrel
 Window Regulators
 GM, Ford, Chrysler '71 - UP
 Box Qty. 100

28002 Box 25



28001

6031091, 9437938, 385323-S100
 Peel-Type Rivet
 Dia.: 1/4" Grip: 33/64" - 19/32"
 Flange Dia.: 1/2"
 Aluminum Rivet, Steel Mandrel
 Window Regulator
 GM, Ford, Chrysler '76 - UP
 Box Qty. 100



38505

N805759-S100
 Dia.: 1/8", Grip: 1/8" - 3/16"
 Black Aluminum Rivet
 Aluminum Mandrel
 Windshield Side Rail
 Ford T-Bird
 Mercury Cougar '89 - UP
 Box Qty. 50

38511 Box 100

38510

25618730, N805592-S100
 Dia.: 3/16"
 Grip: 5/64" - 15/64"
 Flange Dia.: 7/16"
 Black Aluminum Rivet
 Aluminum Mandrel
 Split-Type Rivet
 Wheel House Moulding &
 General Purpose
 Ford, GM
 Box Qty. 25



38520

22093245
 Dia.: 5/32"
 Grip: 1" - 1-15/64"
 Flange Dia.: 5/16"
 Aluminum Rivet,
 Aluminum Mandrel
 Door Lock Actuator
 GM '90 - UP
 Box Qty. 25



38525

9432137, 6032138
 Dia.: 5/32" Grip: 1/8" - 3/16"
 Flange Dia.: 5/16"
 Aluminum Rivet, Steel Mandrel
 Countersunk Head
 Trunk Lock Swivel Emblem Rivet
 Chrysler, GM '73 - UP
 Box Qty. 25

38527

15022087
 Dia.: 1/4", Grip: 3/64" - 5/64"
 Flange Dia.: 19/32"
 Shoulder Dia.: 13/32"
 Steel Rivet (Zinc)
 Steel Mandrel (Zinc)
 Headlight Retainer
 GM Jimmy, Chevy Blazer
 & Oldsmobile Bravada '98 - UP
 Box Qty. 25



38532

21093072
 Blind Rivet
 Dia.: 1/4" Grip: 1/16" - 1/8"
 Flange Dia.: 1/2"
 Steel Rivet (Olive Drab Color)
 Steel Mandrel (Zinc)
 Front Fender Support
 GM Saturn '91 - UP
 Box Qty. 25

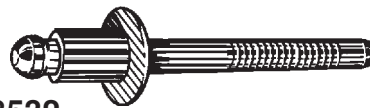

38535

3540146
 Blind Rivet
 Dia.: 1/4", Grip: .060 - .083
 Flange Dia.: 3/4"
 Steel Rivet (Zinc)
 Steel Mandrel (Zinc & Yellow)
 Window Channel
 GM '93 - UP
 Box Qty. 15



38545

22578214
 Blind Rivet
 Dia.: 1/4", Grip .086" to .129"
 Flange: 1/2"
 Steel Rivet, Steel Mandrel
 Window Regulator
 GM 91 - UP
 Box Qty. 15



38550

9437486, 6032926
 Dia.: 1/4", Grip: 9/64" - 3/16"
 Head Dia.: 1/2"
 Aluminum Rivet, Steel Mandrel
 Window Regulator Rivet
 G.M., Chrysler
 Box Qty. 25



38540

21093072
 Blind Rivet
 Dia.: 1/4", Grip: 1/16" - 1/8"
 Flange: 1/2"
 Steel Rivet / Steel Mandrel
 Olive Drab Color
 GM, Saturn
 Box Qty. 25



GM

GM CLIPS & FASTENERS

GM

38555

389268-S100,
201843399,
12338153
Dia.: 1/4"
Grip: 11/16" - 3/4"
Flange Dia.: 1/2"
Peel-Type Rivet
Aluminum Rivet
Steel Mandrel
Window Regulators
Ford & GM
Box Qty. 25



38565

10204266
Dia.: 1/4"
Grip: 3/4" - 1"
Head Dia.: 1/2"
Aluminum Rivet
Aluminum Mandrel
Trunk Lock Cylinder
Pontiac Firebird '95 - '94
Box Qty. 10



38585

22585836, 22641917
Dia.: 3/16"
Grip: 1/16" - 17/64"
Flange Dia.: 3/8"
Steel Rivet (Black)
Steel Mandrel (Zinc)
Rear Side Door
Outside Handle Attachment
Cadillac DeVille & Seville,
Chevy Cavalier &
Pontiac Sunfire '94 - UP
Box Qty. 25



38601

3548690
Dia.: 1/4" Grip: 1/16" - 5/64"
Flange Dia.: 11/16"
Steel Rivet (Zinc)
Steel Mandrel (Zinc & Yellow)
Window Moulding
GM '93 - UP
Box Qty. 15



38602

25551202
Dia.: 3/16" Grip: 1/32" - 1/8"
Shoulder Dia.: 1/4"
Flange Dia.: 1/2"
Steel Rivet (Zinc)
Steel Mandrel (Zinc)
Front & Rear Bumper Fascia
Buick Lesabre '92 - UP
Box Qty. 25



38603

2024778
Dia. 1/4" Grip: 1/16" - 1/4"
Flange Dia.: 1/2"
Steel Rivet (Zinc)
Steel Mandrel (Zinc)
Front Side Door Window Regulator
Chevrolet Lumina APV, Olds
Silhouette & Pontiac Trans Sport
'90 - UP
Box Qty. 25



38605

22643056
Dia.: 1/4" Grip: 1/16" - 5/32"
Flange Dia.: 1/2"
Steel Rivet / Steel Mandrel
Zinc & Yellow Dichromate
Door Window Regulator Rivet
GM '95 - UP
Box Qty. 25



38608

16715497
Dia.: 5/32" Grip: 3/64" - 1/4"
Flange Dia.: 15/32"
Aluminum Rivet, Steel Mandrel
Attaches Support Rails to
Load Floor
GM
Box Qty. 50



38610

01057547
Dia.: 1/4" Grip: 5/64" - 3/8"
Flange Dia.: 1/2"
Yellow Dichromate Coated
Aluminum Rivet, Steel Mandrel
Front Door Window Regulator
GM APV Vans '90 - UP
Box Qty. 10



170025

14044408
Black
4.2mm - 1.41 x 20mm
Torx Drive
Knurled Socket Head
Dash Pad Retaining Screw
GM Firebird, Camaro '82 - UP
Box Qty. 25



170210

M6-1.0 x 20mm
Torx Drive Bolt w/Dog Point
T-30 Torx Drive
18mm Plastic Washer
9.5mm x 5mm Shoulder
GM Saturn '91 - UP
Box Qty. 15



170215

12338094
Black Oxide
M6-1.0 x 45mm
Oval Head T-25 Torx Drive
302 Stainless Steel
Head Dia.: 10mm (3/8")
Luggage Rack Attachment
GM Cars & Vans
Box Qty. 10

GM CLIPS & FASTENERS



200170
367292 & 367291
Chrome Plated Steel
Outside Rearview Mirror
1/4"-20 x 1" Bolt &
Mounting Nut
Chrysler &
GM Trucks & Vans
Box Qty. 10

200175
367291,
14007511
Chrome Plated Steel
1/4"-20 x 1"
Hex Washer Head
Hex: 3/8"
Wshr O.D.: 5/8"
Truck Mirror Mounting Screw
Chrysler & GM Trucks/Vans
Box Qty. 10



200177
11503578,
11503785
Black Phosphate
M4.2-1.41 x 16mm
(#8 x 5/8")
Hex: 7mm
Washer O.D.: 12mm (1/2")
Hex Washer Head Screw
W/ Teks® Point
GM & General Purpose
Box Qty. 50



200293
Black Phosphate
Hex Washer Head
w/ Loose Washer
M4.2 - 1.41 x 20mm
w/ Drill Point
7mm Across Flats
Washer Dia.: 17mm
GM & General Purpose
Box Qty. 50



GM

200380
9423101
Dacromet 320 Finish
License Plate Screw
M6.3-1.81 x 16mm
(#14 x 5/8")
Duo Drive Truss Head
GM Cars & Trucks
'65 - UP
Box Qty. 50



200400
11509604
Black Finish
M6.3 - 1.89 x 25mm
w/ 17mm Washer
Type "AB"
Torx Pan Head
Tapping Screw
GM & General Purpose
Box Qty. 25



266030
Zinc & Yellow
M5- .8 Specialty Insert
Grip: .5mm - 3.3mm
Head Dia.: 10mm
Hex Size: 7mm
GM
Box Qty. 15



266033
10281487
Zinc & Yellow
M6-1.0 Specialty Insert
Grip: .7mm - 4.2mm
Head Dia.: 13mm
Hex Size: 9.5mm (3/8")
Front Fender
Buick, Cadillac, Corvette,
L.D. Truck, Olds Aurora &
Pontiac '97 - UP
Box Qty. 15



280030
1355003
Nylon
Headlight Door To
Radiator Grille
Anchor Nut
#6 or #8 Screw Size
Buick '64 - UP
Box Qty. 50



280040
8934-201-263, 6000943
Nylon
Radiator Grille Nut
#8 Screw Size
AMC-Renault, Chrysler
Box Qty. 50



280070
3893980
Nylon
Front End &
Instrument Panel Nut
#8 Screw Size
GM '67 - UP
Box Qty. 50



280080
1377030
Nylon
Valance Panel To Rear
Bumper Bar Grommet
#6 or #8 Screw Size
GM '71 - UP
Box Qty. 50



280100
3986978
Headlight Bezel Nut
8 Used Per Car
Chevrolet '71 - UP
Box Qty. 25



280135
3907444, 4755299
Nylon
License Plate Nut
Split Four Ways
Under Head
#14 (1/4") Screw Size
GM
Box Qty. 100













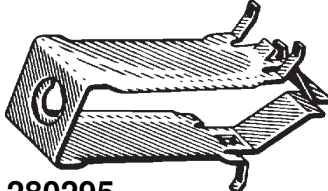

280210
3919773
White Nylon
Headlamp Bezel Nut
#8 Screw Size
GM '74 - UP
Box Qty. 50

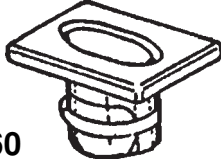
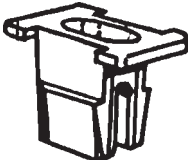

280220
Nylon
Nut Headlamp Bezel
GM Cars &
General Purpose
Box Qty. 50

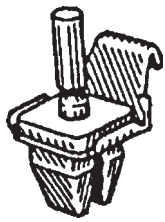

GM CLIPS & FASTENERS

 <p>280230 1254815 Nylon Fenders, Cornering Lights Grommet # 6 Screw Size Hole: 1/4" Panel Range: .060" - .150" GM '77 - UP Box Qty. 50</p>	 <p>280240 1255823, 389360S Nylon #6 or #8 Screw Size Parking Lamp Bezel Tail Light Nut GM Cars '76 - UP Ford '81 - UP Box Qty. 50</p>	 <p>280250 1386805, 6032676 Nylon Radiator Grille Nut # 8 or # 10 Screw Size Chrysler Truck '85, Buick & General Purpose Box Qty. 100</p>	 <p>280295 22514924 Headlight Mounting Bezel Nut Screw Size: #8 (M4.2-1.41) 2" Long Oldsmobile '82 - UP Box Qty. 25</p>
 <p>280300 10004329, 10009690 Natural Nylon Headlight Spacer Nut GM '79 - UP Box Qty. 25</p>	 <p>280315 15078238 Radiator Grille & Bumper Cover Retainer Width: 5/8" Length: 1" GM Trucks/Vans '99 - 2000 Box Qty. 10</p>	 <p>280320 14013246 Nylon Headlight Bezel Nut Fits Into 5/16" Hole #8 Screw Size GM '67 - UP Box Qty. 50</p>	 <p>280350 14032291 Nylon Grille Attachment Grommet #6 or #8 Screw Size GM Box Qty. 50</p>
 <p>280360 22529009 Side Marker Grommet Marker & Headlight Bezel Nut M4.2 or #8 Screw GM "J" & "N" Bodies '84 - UP Box Qty. 50</p>	 <p>280380 Plastic Front Side Marker Lamp Grommet M4.2 Screw Size Rect. Hole: 8.0 x 6.0mm Cadillac "C" Body (Fwd.) '86 - UP Box Qty. 50</p>	 <p>280400 16503548 Nylon & Stainless Steel Nut & Spring Grommet Provides Tension on Headlamp Various GM '83 - UP Box Qty. 25</p>	 <p>280405 16507939 Nut & Spring Grommet with Drive Pin Provides Tension on Headlamp C-K Truck Box Qty. 15</p>
 <p>280410 94141978 Plastic Door to Fender Headlamp Grommet Hole: 9mm x 12mm M5 Screw Size GM Cars '85 - '86 Box Qty. 10</p>	 <p>295090 D7VZ-6050074A, 1259296 Plastic Barrel Nut Hole: 1/4" Ford, G.M. etc. Box Qty. 50</p>	 <p>295280 Plastic Tubular Clip Body Side Moulding Ford Taurus, Sable '86 - UP Box Qty. 100</p>	 <p>300185 22529957 Nylon Front Bumper Fascia Nut M4.2 (#8) Screw Size Washer Face: 25mm Head Dia.: 25mm (1") Hole: 7mm Sq. Oldsmobile Cutlass Ciera '85 - UP Box Qty. 25</p>

GM

GM CLIPS & FASTENERS

GM

302015

15707256
Zinc Organic
Front Fender Extension &
License Plate Bracket
Retainer Nut
Screw Size: M6 - 1.0
GM Express & Savanna
'96 - UP
Box Qty. 10



303120

367292, 6031438
Zinc w/ Sealer
Outside Rear View
Mirror Retainer
Thread: 1/4-20
GM, Chrysler
Box Qty. 25



303125

14007940
Zinc w/ Raintite
Roof Rack
Mounting Nut
Thread: M6-1.0
GM "X" & "Y" Bodies
Box Qty. 10



303126

1623436
Zinc w/ Raintite
Rack Mount Nut
Thread: M5 - .8
GM "J" Body
Box Qty. 10



303255

14001197
Air Cleaner Hold Down
Wing Nut
Thread: M6 - 1.0
Oldsmobile, Pontiac,
Chevrolet, G.M.C. Truck
Box Qty. 25

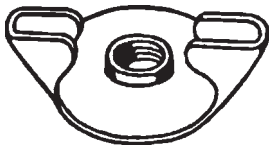

303260

20180178
Plastic
Rear Speaker Cover
Wing Nut
Thread: M6
GM
Box Qty. 25

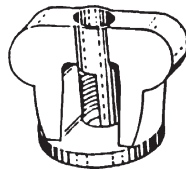

303315

1622920
Luggage Rack Mount
Well Nut
Thread: M5 - .8
Hole Size: 3/8
Oldsmobile '83 - UP
Box Qty. 10



303325

528846, 4003120
Luggage Rack Mount
Well Nut
Thread: 1/4 - 20
Hole Size: 1/2"
G.M. & AMC
Box Qty. 25



303326

20130258
Neoprene Captive Brass
Roof Rack & General
Purpose Well Nut
Thread: M6 - 1.0
Hole Size: 1/2"
Box Qty. 25



303327

20130258
Roof Rack Well Nut
Thread M6 x 1.0
w/ #10 Stainless Screw
Hole Size: 1/2"
GM & General Purpose
Box Qty. 10



340010

5949838
Headlight Adjusting Screw
& Nut assembly
Chevrolet, Buick & Pontiac
Box Qty. 10 Sets

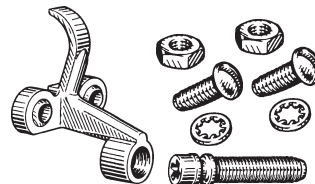

340030

Nylon
Headlight Adjusting Nut
G.M. all early Models
Box Qty. 50

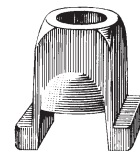

340050

3921446
White Nylon
Headlight Adjusting Nut
Thread Size: 1/4 - 28
Chevrolet
Box Qty. 50



340220

417360
Nylon
Headlamp Adjusting
Screw & Nut
Oldsmobile '75 - '76
Buick '76
Box Qty. 25

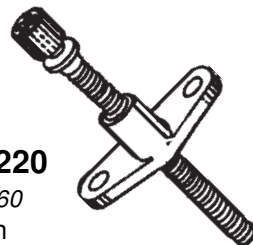

340230

343543
White
Headlamp Adjusting
Screw & Nut Assembly
1/4 - 28 x 2" Screw
Chevette '76 - UP
Mini Van '85 - UP
Box Qty. 25

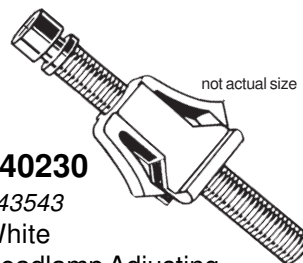

340300

365266
Green
Headlamp
Screw & Nut Assembly
1/4" - 28 x 2" Screw
Chevy Caprice '75 - UP
Full Size Cars '76 - UP
Box Qty. 25

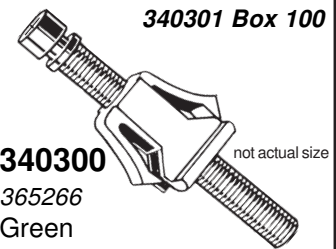

340301 Box 100

GM CLIPS & FASTENERS

 <p>340310 556539 Black Headlamp Adjusting Screw & Nut Assembly 12 - 28 x 1-3/8" Screw Oldsmobile, Buick '77 - UP Box Qty. 25</p>	<p>340331 Box 100</p>  <p>340330 557057 Blue Headlamp Adjusting Screw & Nut Assembly 12 - 28 x 1-1/4" Screw Pontiac '77 - UP "A" Body '82 - UP "P", "C" Body '85 - UP Box Qty. 25</p>	 <p>340350 9436928 Headlamp Adjusting Screw 1/4 - 28 x 2-1/4" G.M. '76 Box Qty. 50</p>	
<p>not actual size</p>  <p>350020 16507452 Headlamp Adjusting Screw & Nut Assembly M5 x 34mm Slotted Torx Screw Horizontal & Vertical Adjustment GM "J" Bodies '87 - UP Box Qty. 10</p>	 <p>360050 3923948 Headlight Tension Spring Chevelle '68 - '76 Box Qty. 10</p>	 <p>360080 1231641 Headlight Adjusting Spring Buick '70 - '72 Box 10</p>	 <p>360290 555388 Headlight Adjusting Spring Oldsmobile '76 - UP "C" Bodies '85 - UP Box Qty. 10</p>
 <p>360330 549398 Headlight Tension Spring Pontiac '78 Firebird & Camaro "A" & "P" Bodies Box Qty. 10</p>	 <p>415010 4801268 Black Nylon Door Flange Weatherstrip Fastener GM Box Qty. 100</p>	 <p>415049 10119816 Black Nylon Air Intake Grille Retainer, Panel Retainer Chevrolet Camaro '91 - UP Box Qty. 25</p>	<p>415051 Box 250</p>  <p>415050 1631564, N804379S Black Plastic Bumper Fascia Retainer Head Dia: 21mm Hole Size: 10mm Length: 28mm Buick, Cadillac & Olds. '81 - UP Ford Taurus & Mercury Sable '86 - UP Box Qty. 25</p>
 <p>415060 4876498 Plastic Weatherstrip Retainer GM Box Qty. 50</p>	<p>415072 Box 250 415071 Box 500</p>  <p>415070 1605396, 6030441, 388577S Black Nylon Radiator Yolk, Fender & Bumper Shield Retainer G.M. Cars, Ford, Chrysler Box Qty. 50</p>	<p>415076 Box 250</p>  <p>415075 21094146, 6501301 Black Nylon Trim Panel Retainer GM Saturn '91 - UP Sliding Door & Lift Gate Trim Panel Retainer Chrysler Mini Vans '87-UP Box Qty. 50</p>	 <p>415080 8731909 Black Nylon Door Weatherstrip Retainer GM '63 - UP Box Qty. 100</p>

GM

GM CLIPS & FASTENERS

415100

20413107, 388246S,
4006516
Black Nylon
Weatherstrip
Fastener
General Purpose
GM, Ford, AMC
Box Qty. 50



415125

N803362-S,
20510029
Black Nylon
Body Retainer
Hole: M6
Flange: 18mm
Fits Into 1/4" Hole
Ford Escort, Lynx '84 - UP
Pontiac Fiero '85 - UP
Box Qty. 25



415131

21047094
Black Nylon
Push-Type Retainer
Head Dia.: 5/8"
Stem Length: 5/8"
Fits Into 1/4" Hole
GM Saturn '91 - UP
Box Qty. 25



415135

10157900
Black Nylon
Front Bumper
Fascia Retainer
Head Dia.: 18mm
Fits Into 9.5mm Hole (3/8")
Oldsmobile Cutlass
'90 - UP
Box Qty. 25



415138

20570245,
N804614-S
Black Nylon
Drive Rivet
Head Dia.: 1"
Stem Length: 7/8"
Fits Into 5/16" Hole
G.M. '84 - UP
Ford Products
Box Qty. 25



415145

10082553
Black Nylon
Rear Bumper
Fascia Retainer
Head: 14mm x 22mm
Fits Into 12.5mm (1/2") Hole
Oldsmobile Cutlass '90-UP
Box Qty. 25

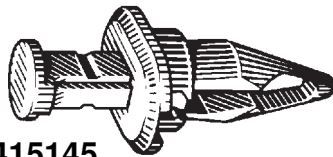

415150

389809,
C6GY-16776-A
Plastic
Hood Insulation Retainer
1-1/2" x 1-1/2"
GM, Ford
Box Qty. 50

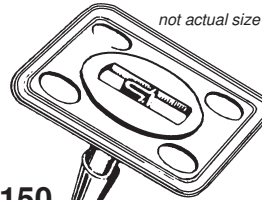

415210

411700
Trim Panel Retainer
GM
Box Qty. 50



415221 Box 250
415222 Box 500

415220

3977775,
3078511
Hood Insulation Clip
Head Dia.: 2"
Length: 3/4"
GM '64 - UP
Can be used on other cars
Box Qty. 50



415235

21039141,
15678493
Plastic
Hood Insulation Retainer
Lg. Head Dia.: 1-9/16"
Length: 1/2"
Hole: 1/4"
GM Saturn '91 - UP
Box Qty. 25



415451 Box 250

415450

1619321
Black Nylon
Radiator Apron
Panel Retainer
GM '77 - UP
General Purpose
Box Qty. 50



415480

5973996
Brown Nylon
Fascia Retainer
Head Dia.: 1"
Panel Range: 1/4"
Fits Into 1/2" Hole
GM Cars '82 - UP
Box Qty. 25



415490

5973400
Black Nylon
Fascia Retainer
Head Dia.: 1"
Panel Range: 1/8"
Fits Into 1/2" Hole
GM Cars '79 - UP
Box Qty. 25



415503

175-853-695,
14015161
Black Plastic
Grille Attaching
Drive-Type Rivet
Hole: 5/16"
Flange: 5/16" x 1-1/16"
GM & VW
Box Qty. 50



415506 Box 500

415505

14019206
Black Nylon
Fender Liner Retainer
Head Dia.: 11/16"
Fits Into 1/4" Hole
GM Cars '83 - UP
Box Qty. 50



GM

GM CLIPS & FASTENERS

415518

21077405
Black Nylon
Door Handle to Door
Retainer
Head Dia.: 7mm
Stem Length: 10mm
Fits Into 5mm Hole
GM Saturn '91 - UP
Box Qty. 25



415525

10053388
Black Nylon
Bumper Fascia
Retainer
Head Diameter: 1"
Panel Range: 1/8"
Stem Length: 1-7/64"
Fits into 1/2" Hole
GM 1987 - On
Box Qty. 25



415597

N-804570-S,
20664092,
6502790
Black Plastic
Cowl & Interior Trim
Screw-Type Rivet
Hole: M6.3
Grip: 2.5mm - 8mm
Washer Face Dia.: 18mm
Ford, GM, Chrysler &
Cadillac '98 UP
Box Qty. 25

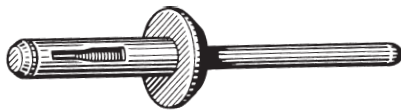

415600.....Box 25
415800.....Box 100
20452072, N803862-S, 6501559
6.3mm Dia. Nylon Blind Rivet
Panel Range: 4mm to 10mm
Flange: 13mm
G.M., Ford, Chry., General Purpose

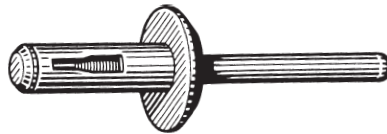

415602.....Box 25
415802.....Box 100
14063981, N803043-S, 6500911
6.3mm Dia. Nylon Blind Rivet
Panel Range: 4mm to 10mm
Flange: 17mm
G.M., Ford, Chry., General Purpose

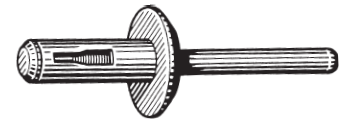

415610.....Box 25
415810.....Box 100
20421672
6.63mm Dia. Nylon Blind Rivet
Panel Range: 2.5mm to 5mm
Flange: 13mm
G.M., General Purpose

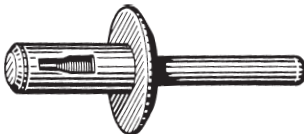

415620.....Box 25
415820.....Box 100
20433026, 175-853-577A
6.63mm Dia. Nylon Blind Rivet
Panel Range: 2.5mm to 5mm
Flange: 18mm
G.M., VW, General Purpose

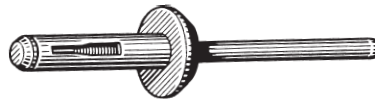

415630.....Box 25
415830.....Box 100
6500898
5mm Dia. Nylon Blind Rivet
Panel Range: 6mm to 10mm
Flange: 12mm
Chrysler, General Purpose

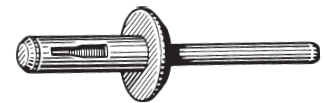

415640.....Box 25
415840.....Box 100
20432975, 175-853-57701C
5mm Dia. Nylon Blind Rivet
Panel Range: 3mm to 6mm
Flange: 12mm
G.M., VW, General Purpose

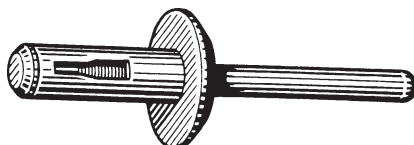

415650
20423647, N804189S
Black Super Tough Nylon
Blind Rivet
Hole: 3/16, Flange: 1/2"
Grip: 1/16" - 5/32"
Ford, GM
Box Qty. 25

415651

10108746
Black Nylon
Front Bumper
Fascia Retainer
Head Dia.: 20mm
Fits Into 10mm Hole
GM '91 - UP
Box Qty. 25

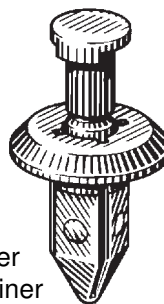

415653

24512415
Plastic
Radiator Grille
Filler Panel
Drive Type Rivet
Hole: M10
Flange: 20mm
GM & Olds '88, '92 - UP
Box Qty. 15

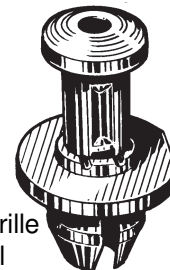

415664 Box 100

415663

16500308, 6500787
Black Nylon
Tail Light Retainer
Fits Into 3/16" Hole
GM, Chrysler
Box Qty. 25



GM

GM CLIPS & FASTENERS

415666

20514862
Plastic
Grille to Shroud Retainer
Vent Grille to
Windshield Shroud
GM "N" & "L" Bodies
'85 - UP
Box Qty. 100



415670

1690410
Black Nylon
Front Fender Flap Clip
Hole: 3/16"
Head: 5/8"
GM, Cadillac '80 - UP
Box Qty. 50

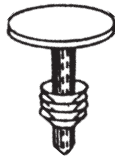

415781 Box 100

415780

10053182
Screw Type Rivet
Body Splash Shield
Hole: M8 Flange: 15mm
P.R.: 2-10mm
GM "W" Body '88 - UP
GM "J" '95 - UP
Box Qty. 25



415785

101404480, 6502625
Black Nylon
Push-Type Retainer
Head Dia.: 21mm (27/32")
Panel Range: 3mm (1/8")
Stem Length: 25mm (1")
Fits Into 12mm (1/2") Hole
GM, Chrysler
Box Qty. 25



415790

6501544, N803170-S
Nylon Retainer
Hole: M5
Head: 10mm
Ford Mustang,
Capri '84 - UP
Chrysler Imports
Box Qty. 50



415795

14103435, 12337900
Nylon
Upper Radiator
Shield Retainer
Chevrolet Corsica &
Beretta '87 - UP
Box Qty. 15



415798

15686142,
N802865
Zinc Phosphate
Grille, Bumper &
Radiator Support Nut
Screw: M4.2 or #8
Lincoln '83 - UP
G.M. "CK"
Truck '93 - UP
Box Qty. 25



415883

15149708
Plastic
Front Wheel Splash,
Lower Radiator Shields
Drive-Type Rivet
Hole: M6.3
Flange: 17mm
P.R.: 6mm
GM "C/K" Trucks '99 - UP
GM "G", "S" & "T" Trucks
'96 - UP
Box Qty. 25



415886

21077131
Black Nylon
Bumper Fascia
Push-Type Rivet
Head Dia.: 1-3/16"
Stem Length: 2"
Fits Into 7/16" Hole
GM Saturn '91 - UP
Box Qty. 10

not actual size



415888

21075686
Black Nylon
Wheel Wells,
Front Bumper
Drive-Type Rivet
Hole: M8
Flange: 15mm
P.R.: 3-8mm
GM Corvette '97 - UP
GM Saturn '91 - UP
Box Qty. 25



415889

21030249,
N807389S,
6503598
Black Nylon
Air Baffle To
Under Carriage
Push-Type Rivet
Head Dia.: 20mm
Stem Length: 20mm
Fits Into 8mm Hole
GM Saturn '91 - UP
Box Qty. 25



415891 Box 100

415892

20730531
Plastic
Cowl Vent
Push-Type Rivet
Hole: M6
Flange: 15mm
P.R.: 5mm
GM Saturn '91 - UP
Box Qty. 25

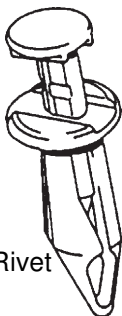

415920

63844-D0100,
8942211500
Nylon
Push-Type Retainer
5mm x 14mm Screw
Head Size: 14mm x 22mm
Stem Length: 9mm
Fits into a 7mm Hole
Nissan, Isuzu
Box Qty. 25

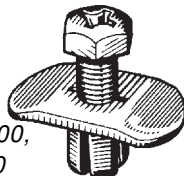

415922

15959832
Black Nylon
Front License
Plate Push-Type
Retainer
Head Dia.: 1"
Stem
Length: 1-5/8"
Fits Into 1/2" Hole
GM Truck '94 - UP
Box Qty. 10



415960

96057847,
09409-07313
Black Nylon
Radiator Grille &
Trim Panel
Push-Type Retainer
Head Dia.: 11mm
Stem Length: 14mm
Fits Into 7mm Hole
Geo Tracker & Prizm
'89 - '92
Box Qty. 10



GM CLIPS & FASTENERS

 <p>415963 25695687 Black Nylon Radiator Support Sight Shield Retainer Head Dia.: 27mm Shoulder Dia.: 10mm Stem Length: 18mm Fits Into 9mm Hole Cadillac DeVille & Seville '2000 - UP Box Qty. 15</p>	 <p>415965 96057846, 09409-07308-281 Black Nylon Push-Type Retainer Head Dia.: 15mm Stem Length: 13mm Fits Into 6.3mm Hole Geo Metro & Tracker '89 - UP Box Qty. 10</p>	 <p>415992 4001916 Black Nylon Weatherstrip Retainer Hole: 5/16" Head: 3/16" x 9/16" P.R.: .050 Jeep & GM Trucks Box Qty. 50</p>	 <p>415996 15672328 Black Nylon Radiator Grille Retainer GM S-10 & S-15 Pick-ups '91 - UP Box Qty. 25</p>
 <p>416005 15682898 Nylon Radiator Grille Clip GM S-10 Trucks '94 - UP Box Qty. 25</p>	 <p>416008 22587036 Nylon Rear Bumper Fascia Push-Type Retainer Head Dia.: 1" Stem Length: 15/16" Fits into 3/8" Hole Chevrolet Cavalier & Pontiac Sunfire '95 Box Qty. 25</p>	 <p>416010 14074081 Black Nylon Rear Hood Seal Retainer GM '83 - UP Box Qty. 25</p>	 <p>416012 3548804 Black Nylon License Plate Bracket & Bumper Fascia Retainer Cadillac Eldorado & Seville '95 - UP Box Qty. 25</p>
 <p>416013 10098645 Black Nylon Front Door Lower Moulding Retainer Pontiac Grand Prix '94-UP Box Qty. 50</p>	 <p>416014 10158124 Natural Nylon Trim Panel Retainer Buick, Oldsmobile & Pontiac '92 - UP Box Qty. 50</p>	 <p>416015 21095797 Black Nylon Bumper Fascia Push Retainer Head Dia.: 13/16" Stem Length: 1-3/32" Fits Into 5/16" Hole GM Saturn '96 Box Qty. 25</p>	 <p>416035 3540858 Nylon Radiator Air Baffle Push Type Retainer Head Dia.: 3/4" Stem Length: 1-1/8" Fits In 1/4" Hole Cadillac Eldorado & Seville '93 - UP Box Qty. 25</p>
 <p>416046 14019226, 14071289 Black Nylon Radiator Overflow Bottle/Windshield Washer Bottle Retainer Head Dia.: 21/32" Stem Length: 9/16" Fits Into 5/16" Hole GM '81 - UP Box Qty. 50</p>	 <p>416047 390018-S, 10121502 Black Nylon Shield Retainer Battery Post Cable Shield, Engine Splash Shield Radiator Side Air Baffle Head Dia.: 11/16" Stem Dia.: 5/16" Stem Length: 1-1/16" Ford, GM '89 - UP Box Qty. 50</p>	 <p>416118 11518017, W708530-S300 Black Nylon Bumper Cover & Fender Shield Retainer Head Dia.: 20mm Stem Length: 26mm P.R.: 3 - 5mm Fits Into 8mm Hole GM, Ford '97 - UP Box Qty. 15</p>	 <p>416146 6501925, 10134407 Nylon Push Type Ret. Head Size: 11/16" Stem Length: 13/16" Fits Into 1/4" Hole Chrysler Concorde & LHS, Dodge Intrepid Eagle Vision '93 - UP Coolant Recovery Res. GM '92 - UP Box Qty. 25</p>

GM

GM CLIPS & FASTENERS

416152

25535963,
N811772-S
Plastic-Twist Lock
Site Shield &
H/L Shroud Cover
Retainer
GM "C", "H" & "N" Bodies
'94 - '96
Ford Full Size
Lincoln Town Car '98 - UP
Box Qty. 15



416156

20064875
Black Nylon
Hood Insulation
Retainer
GM '80 - UP
Box Qty. 25



416158

15733971
Black Nylon
Front Air
Deflector Ret.
Sm Head Dia.: 18mm
Lg Head Dia.: 26mm
Flange Dia.: 30mm
Stem Length: 24mm
(Use with #416160)
C & K Trucks '99 - UP
Box Qty. 15



416160

15733970
Black Nylon
Front Air Deflector
Grommet
Head Dia.: 28mm
Stem Length: 13mm
(Use with #416158)
C & K Trucks '99 - UP
Box Qty. 25



416162

10246149
Black Nylon
Rocker Panel
Push-Type Retainer
Head Dia.: 13mm
Stem Length: 20mm
Fits Into 6mm Hole
Achieva, Cutlass,
Grand Am & Malibu
'99 - UP
Box Qty. 25



416164

22657634
Black Nylon
Fender &
Rocker Panel
Push-Type Retainer
Head Dia.: 12mm
Stem Length: 17mm
Fits Into 6mm Hole
Achieva, Cutlass,
Grand Am & Malibu
'99 - UP
Box Qty. 25



416166

1636632,
20687704
Black Nylon
Front Bumper
Fascia Retainer
Head Dia.: 17mm
Fits Into 9.5mm (3/8") Hole
Buick Riviera/Reatta
'88 - UP
Box Qty. 25

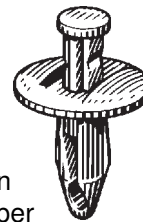

416168

25663903
Black Nylon
Upper Radiator
Shield Push-Type
Retainer
Head Dia.: 1"
Stem Length: 1"
Fits Into 1/4" Hole
Cadillac DeVille & Seville
'98 - UP
Box Qty. 15



416169

14045480
Black Nylon
Front & Rear
Fascia Attachment Rivet
Hole: 5/16", P.R.: 1/8" - 1/4"
Head Dia.: 1"
GM '82 - UP
Box Qty. 25



416170

10283414,
10405030
Door Weatherstrip
Retainer
GM '97 - UP
Box Qty. 50



416171

15056810, 6505686AA
Black Nylon
Bumper Fascia Retainer
Head Dia.: 25mm
Stem Dia.: 13mm
Stem Length: 15mm
GM, Chrysler 2002 - UP
Box Qty. 25



416175

10287971,
15600382,
10408480
Plastic
Door Panel Retainer
Hole: M7
O/L: 20mm
Head Dia: 18mm
P.R. 2-7mm
GM U & W Bodies '97
Box Qty. 50



416177

20511451
Black Nylon
Cowl Vent Retainer
GM '84 - UP
Box Qty. 25

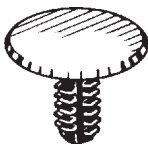

416184

11561368,
6508712AA
Black Nylon
Fender, Wheel &
Bumper Retainer
Head Dia.: 18mm
Stem Length: 20mm
P.R.: 3mm - 5.8mm
Fits Into 9.5mm Hole
GM, Chrysler
Box Qty. 15



E
r
g
o

T
u
f
i
o
k

416186

11589293,
W712196-S300
Black Nylon
Cowl Vent &
Fender Retainer
Head Dia.: 20mm
Stem Length: 22mm
P.R.: 4.5mm - 7.0mm
Fits Into 8.5mm Hole
GM, Ford
Box Qty. 25



E
r
g
o

T
u
f
i
o
k

416190

06508863AA,
11589289
Black Nylon
Air Defroster/
Windshield Defroster
Push-Type Retainer
Head Dia.: 18mm
Stem Length: 17.5mm
PR: 2.0mm - 4.5mm
Fits Into 6.5mm Hole
GM, Chrysler
Box Qty. 25



E
r
g
o

T
u
f
i
o
k

GM

GM CLIPS & FASTENERS

<p>416192 11589290 Black Nylon Air Inlet Grille/ Bumper Fascia Push-Type Retainer Head Dia.: 18mm Stem Length: 20mm PR: 4.5mm - 7.0mm Fits Into 6.5mm Hole GM Box Qty. 50</p> 	<p>416194 W71331-S300, 11589291 Black Nylon Air Dam/Grille Push-Type Retainer Head Dia.: 18mm Stem Length: 22mm PR: 7.0mm - 9.5mm Fits Into 6.5mm Hole GM, Ford Box Qty. 25</p> 	<p>416196 05116530AA, 15296830 Black Nylon Fascia/General Purpose Push-Type Retainer Head Dia.: 19mm Stem Length: 16mm PR: 5.0mm - 7.0mm Fits Into 8mm Hole GM, Chrysler Box Qty. 25</p> 	<p>416198 11589292 Black Nylon Bumper Fascia, Flares & Air Dam Push-Type Retainer Head Dia.: 20mm Stem Length: 20mm PR: 2.0mm - 4.5mm Fits Into 8.5mm Hole GM Box Qty. 25</p> 
<p>416200 11609417 Black Nylon Fender Apron Push-Type Retainer Head Dia.: 19mm Stem Length: 14mm PR: 2.7mm - 5.3mm Fits Into 8.5mm Hole GM Box Qty. 50</p> 	<p>416204 11589294 Black Nylon Bumper Fascia, Fender, Toe/Floor Panel Push-Type Ret. Head Dia.: 20mm Stem Length: 24mm PR: 7.0mm - 10.0mm Fits Into 8.5mm Hole GM Box Qty. 25</p> 	<p>416208 W712665-S300, 11589295 Black Nylon Fender, Flare, Gas Tank & Panel Attchmnt Push-Type Ret. Head Dia.: 25mm Stem Length: 20mm PR: 3.0mm - 6.0mm Fits Into 10.5mm Hole GM, Ford, Chrysler Box Qty. 15</p> 	<p>416210 11589296 Black Nylon Panel Attchmnt Gen. Purpose Push-Type Ret. Head Dia.: 25mm Stem Length: 23mm PR: 6.0mm - 9.0mm Fits Into 10.5mm Hole GM Box Qty. 15</p> 
<p>420010 7731589 Blue Nylon Qtr. Panel Reveal Mldg & Landau Top Mldg Clip GM Box Qty. 100</p> 	<p>420015 10323057 White Nylon Rocker Moulding Clip Top Head Size: 12mm x 20mm Stem Length: 14mm Fits Into 9mm Hole Pontiac Grand Prix 2004 - UP Box Qty. 15</p> 	<p>420030 8933059, 4492962 Nylon Body Side, Wheel Opening Moulding Clip Buick, Chevrolet & Oldsmobile '68 - UP Box Qty. 100</p> 	<p>420070 Black Nylon Qtr. Panel Reveal Mldg. & Landau Top Moulding Clip GM Box Qty. 100</p> 
<p>420090 9727078 Nylon Belt Moulding Clip GM Box Qty. 50</p> 	<p>420110 8799350 Nylon Door, Quarter Panel & Rear End Moulding Clip GM '70 - UP Box Qty. 100</p> 		

GM

GM CLIPS & FASTENERS



420280

1688094
Nylon
Vinyl Top Moulding Clip
(Narrow mldg, roof top)
Chevrolet, Cadillac &
Oldsmobile '74 - UP
Box Qty. 50

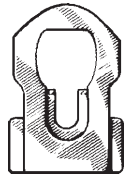

420290

1660123
Nylon
Belt Moulding Clip
GM '75 - UP
Box Qty. 100

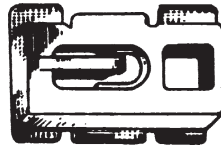

420340

Rear View Mirror Bracket
(Windshield Mounting)
Ford & GM Cars
Box Qty. 50

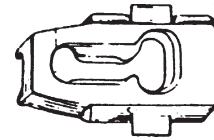

420520

468881
Body Side
Moulding Retainer
GM '78 - UP
Box Qty. 50

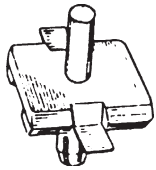

420570

1255628
Moulding Retainer
GM '77 - UP
Box Qty. 25



420690

20119600
Finishing Moulding Clip
Lift Off Panel Opening
GM '79 - UP
Box Qty. 25

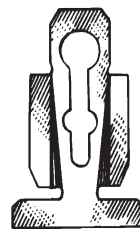

420710

20161379
Roof Clip
Cover Finishing
Moulding (Front)
GM '79 - UP
Box Qty. 25

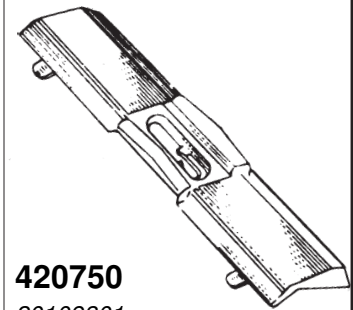

420750

20109301
Belt Moulding Clip
GM '79 - UP
Box Qty. 50



420860

20175051, 15633873
Nylon
Quarter Belt Reveal
Moulding Clip
GM '80 - UP
Box Qty. 50

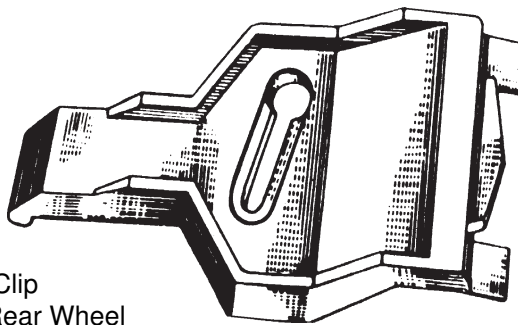

420880

20199336
Moulding Clip
Front Of Rear Wheel
Opening
GM '80 - UP
Box Qty. 10

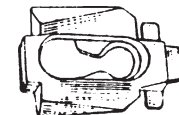

420940

20071874
Belt Moulding Clip
Used on Vinyl Tops
GM '78 - UP
Box Qty. 50

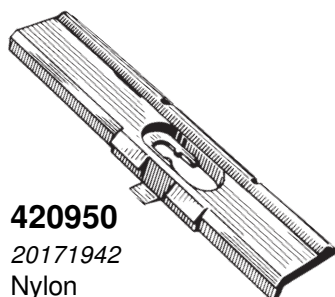

420950

20171942
Nylon
Moulding Clip
(6 Used Per Car)
GM '80 - UP
Box Qty. 25



GM CLIPS & FASTENERS

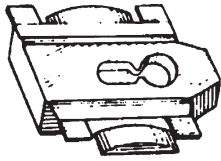

420960
20199337
Roof Panel Clip
GM '81 - UP
Box Qty. 50

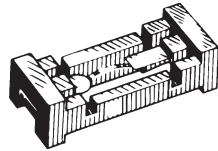

420990
14022878
Moulding Clip
GM '81 - UP
Box Qty. 50

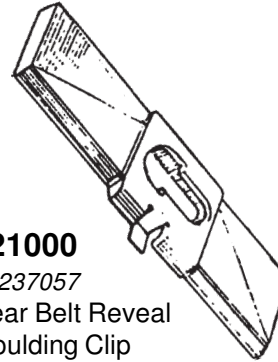

421000
20237057
Rear Belt Reveal
Moulding Clip
GM '80 - UP
Box Qty. 50

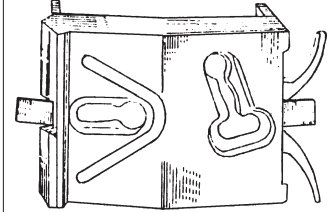

421010
10013154
Rocker Panel Moulding
Clip
GM '81 - UP
Box Qty. 25



421050
20199675
Belt Moulding Clip
GM '80 - UP
"C" Bodies '85-UP
Box Qty. 100

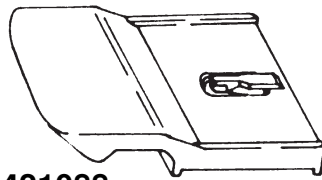

421088
20687369
Plastic
Lower Body Side
Moulding Clip
Cadillac Brougham (RWD)
'90 - UP
Box Qty. 15



421105
20444104
Door Moulding Clip
GM '84 - UP
Box Qty. 25



421120
25500454
Nylon
Rocker Panel
Moulding Clip
GM '81 - UP
Box Qty. 50

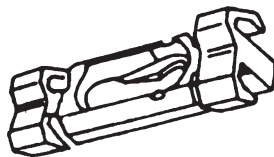

421122
20766166
Plastic
Roof Moulding Clip
Cadillac Sedan DeVille
'89 - UP
Box Qty. 25

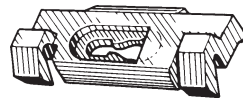

421130
22512114
Nylon
Rocker Panel
Moulding Clip
GM '82 - UP
Box Qty. 50



421150
20481545
Plastic
Body Side Moulding Clip
Oldsmobile "C" Body
(FWD)
'85 - UP
Box Qty. 50

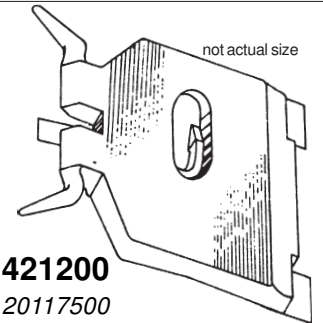

421200
20117500
Front, Rear Door & Side
Moulding Clip
GM '80 - UP
Box Qty. 25

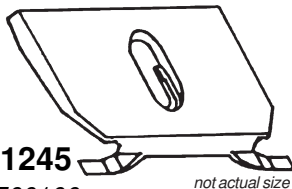

421245
20766166
Plastic
Roof Transverse
Moulding Clip
Buick Century & Regal
'78 - '80
Oldsmobile Cutlass '78 - '80
Box Qty. 25

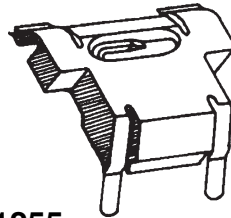

421255
20222445
Lower Quarter Window
Reveal Moulding Clip
GM '82 - UP
Box Qty. 25

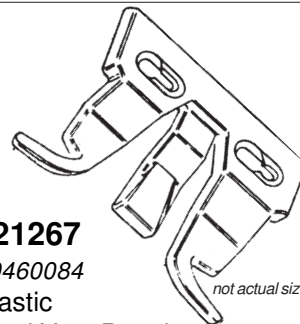

421267
20460084
Plastic
Cowl Vent Panel to
Fender (Right) Clip
GM "A" Bodies '83 - UP
Box Qty. 10

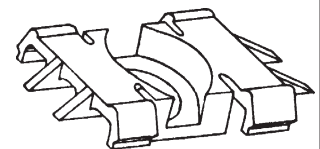

421278
20356051
Plastic
Fender & Quarter
Mouldings Clip
GM '84 - UP
Box Qty. 25

GM

GM CLIPS & FASTENERS

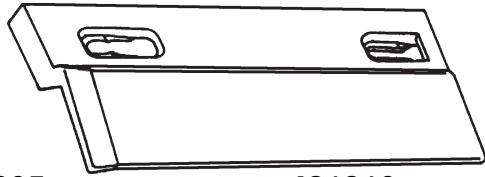

421305

20641048, 10091280
Plastic
Rocker Panel
Moulding Clip (Right Hand)
Accent Moulding
Pontiac Grand Prix '88-UP
Box Qty. 15

421310

20641049, 10091281
Plastic
Rocker Panel
Moulding Clip (Left Hand)
Accent Moulding
Pontiac Grand Prix '88-UP
Box Qty. 15

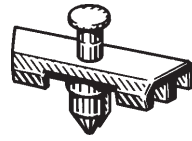

421360

21093588
Nylon
Roof Drip
Moulding Clip
2 Dr & 4 Dr Models
GM Saturn '91 - UP
Box Qty. 25

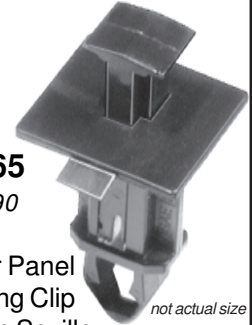

421365

3531990
Nylon
Rocker Panel
Moulding Clip
Cadillac Seville
& Touring Sedan
'94 - UP
Box Qty. 5

not actual size

GM



421375

22603384
White Nylon
Rocker Panel
Moulding Clip
Head Size: 3/4" x 1-3/16"
Stem Length: 19/32"
Fits Into 7/16" Hole
Oldsmobile Alero &
Pontiac Grand Am '99 - UP
Box Qty. 15

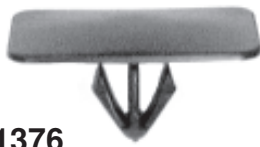

421376

10431524
Black Nylon
Rocker Panel Mldg. Clip
Head Size: 11/16" x 1-5/16"
Stem Length: 9/16"
Snaps Into 5/16" Hole
GM 2000 - UP
Box Qty. 15



421377

10437565
Black Nylon
Rocker Panel Mldg. Clip
Head Size: 15/32" x 1-5/16"
Stem Length: 9/16"
Snaps Into 5/16" Hole
GM 2000 - UP
Box Qty. 10



421378

10431761,
10411395
Gray Nylon
Rocker Panel Mldg. Clip
Top Hd: 11/16" x 1-1/2"
Bottom Hd: 7/8 x 1-9/16"
Stem Length: 1-1/4"
Snaps Into 7/16" Hole
GM 2000 - UP
Box Qty. 15

not actual size



421379

25693852
Gray Nylon
Rocker Panel Mldg. Clip
Top Hd: 9/16" x 1/2"
Bottom Hd: 5/8 x 3/4"
Stem Length: 9/16"
Snaps Into 7/16" Hole
GM '95 - UP
Box Qty. 25

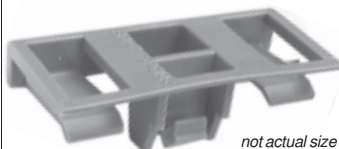

421380

25722671
Gray Nylon
Rocker Panel Mldg. Clip
Width: 7/8, Length: 2"
GM 2000 - UP
Box Qty. 10

not actual size



421381

10443956
11518357
Nylon
Rocker Panel Mldg. Clip
Top Hd: 9/16" x 13/16"
Bottom Hd: 13/16 x 13/16"
Stem Length: 9/16"
Snaps Into 7/16" Hole
GM 2000 - UP
Box Qty. 25



445360

9818648, 9883583,
2064891
White Nylon
Door Trim Panel &
Headlight Retainer
GM '71 - UP
Box Qty. 100



445365

20421800, 15600382
White Nylon
Door Trim
Panel Retainer
GM '83 - UP
Box Qty. 25



445375

11588650
Zinc
Garnish, Interior Trim Bezel
& Scuff Plate Fastener
Width: 15/32"
Height: 11/16"
GM Cars / Light Trucks
2002 - UP
Box Qty. 10



445585













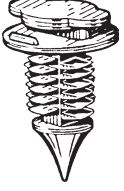

6003349, 9685057,
4005470, N98905101
White Nylon
Door Trim Panel Retainer
GM, Chrysler, AMC, VW
'76 - UP
Box Qty. 25



445590

363137
White Nylon
Trim Panel Retainer
Chevrolet & GMC
Pick-Up Trucks '76 - UP
Box Qty. 25

GM CLIPS & FASTENERS

<p>445595 20451401 White Nylon Conduit to Sheet Metal In Doors Retainer Stud Dia.: 1/4" Length: 1-1/8" Head Dia.: 15/16" GM "C" Bodies '85 - UP Box Qty. 25</p> 	<p>445620 3065575 White Nylon Door Trim Panel Retainer GM '77 - UP Box Qty. 50</p> 	<p>445622 15545202 White Nylon Door Trim Panel Retainer G.M. Trucks '88 - UP Box Qty. 50</p> 	<p>445623 20298365, 6013122 Natural Nylon Trim Panel Retainer GM '82 - UP Chrysler '76 - UP Box Qty. 50</p> 
<p>445625 1699250 Natural Plastic Trim Panel Retainer GM '77 - UP Box Qty. 50</p> 	<p>445626 White Plastic Interior Trim Nut GM Cars '82 - UP Box Qty. 25</p> 	<p>445629 10153057 Door & Qtr. Trim Panel Clip Hole Dia.: 7mm O/L: 30mm GM "W" Bodies '89 - UP Box Qty. 50</p> 	<p>445645 10285935 White Nylon Trim Retainer Buick Century & Regal, Chevrolet Venture, GM Truck, Express/Savana, Olds Silhouette & Pontiac Trans Sport '97 - UP Box Qty. 50</p> 
<p>445655 15607165, 15612948 White Nylon Front Door Trim Panel Retainer GM Trucks '88 - UP Box Qty. 25</p> 	<p>445770 20119536 Door & Quarter Trim Panel Retainer GM '79 Box Qty. 50</p> 	<p>445884 22651066 Yellow Nylon Trim Panel Retainer GM '96 - UP Box Qty. 25</p> 	<p>445895 15960325 White Nylon Door Trim Panel Push-Type Retainer Head Dia. 9/16" Stem Length: 41/64" Fits Into 1/4" Hole GM Trucks C,K 1,2,3 '95 - UP Box Qty. 50</p> 
<p>445896 25704141 Green Nylon Door Trim Panel Retainer with Sealer Hole: M9, Head: 19.5mm O/L: 27.8mm GM 2000 - UP Box Qty. 10</p> 	<p>445897 25696693 White Nylon Door Trim Panel Retainer with Sealer Hole: M9, Head: 19.5mm O/L: 31.6mm Cadillac '98 - UP Box Qty. 10</p> 	<p>445898 25670009, F58Z-16237A02-A, Yellow Nylon Door Trim Panel Retainer Hole: 5/16" Head Dia: 1/2" O/L: 15/16" Ford Windstar '95 - UP Cadillac Seville '98 - UP Box Qty. 25</p> 	<p>470070 1717924 Trunk Lid Bumper Dia.: 11/16" Length: 3/4" GM '79 - UP Box Qty. 10</p> 

GM

GM CLIPS & FASTENERS

470090

4272450
Hood Bumper
Dia.: 15/16"
Length: 1-5/16"
GM "X" Cars '80 - UP
Saturn '91 - UP
Box Qty. 10



470125

Hood Bumper
M8-1.25 x 38mm
GM '78 - UP
Box Qty. 5



471115

PVC Plastic
Door Lock
Striker Bushing
I.D.: 9/16"
O.D.: 11/16"
Length: 3/4"
GM '77 - UP
Box Qty. 10

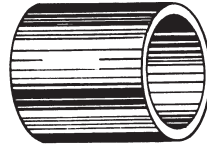

471215

15591860
Stainless Steel
Door Hinge Pin
Pin Length: 5-1/4", Pin Dia. 11/32"
Shoulder OD: 3/8", Hd OD: 9/16"
(Use With #471220 & #471221)
GM Trucks, C-K Models '88 - UP
Box Qty. 5

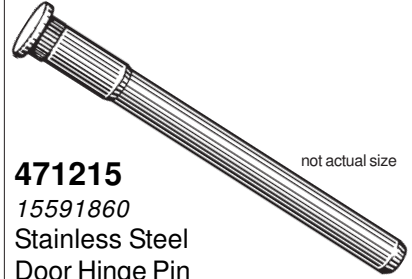

GM

471217

15653790
Zinc & Yellow
Door Hinge Pin
Length: 4-1/8"
Pin Dia.: 11/32"
Shoulder O.D.: 3/5"
Head O.D.: 1/2"
(Use With #471222)
GM S & T Trucks '94 - UP
Box Qty. 2



471220

12338074,
15691493
Upper Side Door
Hinge Bushing
Splined O.D.
GM Trucks,
C-K Models
'88 - UP
Box Qty. 25



471221

15562609
Lower Side Door
Hinge Bushing
Splined O.D.
GM Trucks,
C-K Models
'88 - UP
Box Qty. 25



471222

15562610
400 Series Stainless
Door Hinge Pin Retainer
I.D.: 21/64"
O.D.: 9/16"
1/64" Thick
(Use With #471215 or #471217)
GM Trucks, C-K Models '88 - UP
Box Qty. 50



471224

Door Hinge Pin & Bushing
Repair Kit
GM C/K Trucks &
Full Size SUV's '99-UP
Box Qty. 1 Kit



Each Kit Contains:
2 Case hardened forged pins, with Dacromet
Finish (500 hr Salt Spray)
2 Bronze bushings
2 Thru hardened washers
2 Prevailing torque lock nuts

475080

1241972, 554343,
562327
Bumper Fastener
GM '73 - UP
Box Qty. 50

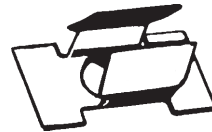

475155

14083173, 17988488,
17997722, 25536302,
N803685-S
Front Bumper, Side/High Stop
Lamps, Rear Wheel Flare &
Interior Trim/Dash Mounting Nut
Screw: M4.2 (#8)
Hole: 9 x 11mm
GM, Saturn, Hummer, Ford,
Jeep '82 - UP
Box Qty. 25



475180

383212-S-2
Transmission Clip
GM '54 - UP
Box Qty. 50



475200

3979975
Hood Release Cable Clip
GM Cars
Box Qty. 15



475440

561258
Tee Bolt and Nut Kit
Bumper Strips and
End Attaching
6mm
Oldsmobile '78 - UP
Box Qty. 25



475455

1613543
Headlight Door Clip
GM '79 - UP
Box Qty. 25



475470

1612276
Headlamp
Door Stud
Cadillac '77 - UP
Box Qty. 25



GM CLIPS & FASTENERS

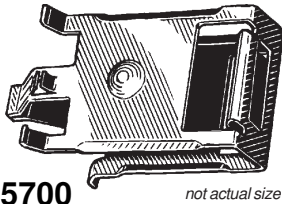

475700
15632790
Zinc organic
Grille Clip
GM S10, S15 Pick-ups
'91-UP
Box Qty. 5

not actual size



475705
16662182
Zinc
Windshield/Rear Side Door
Garnish Moulding & Liftgate
Trim Panel Fastener
Chev. Camaro, Corvette,
Venture; Olds Silhouette;
Pont. Firebird, Grand Prix,
Transport '93 - UP
Box Qty. 15



490010
1247872, 15567924
Throttle Rod Clip
For 1/4" Rod
w/ 5/32" Groove
O.D.: 19/32"
GM '75 - UP
Box Qty. 100

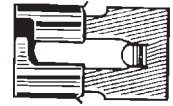

495040
9711304, 3998009,
12337868
Door Lock Rod Clip
GM '56 - UP
Box Qty. 50



495050
4234830
Door Lock Rod Clip
GM '64 - UP
Box Qty. 50



495195
16629990,
16675980
Gray Nylon
Door Lock Rod Clip
Buick, Cadillac, Chevrolet,
Oldsmobile, Pontiac &
Trucks
'96 - UP
Box Qty. 15

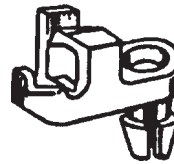

495210
3081052, 469716
Door Lock Rod End Clip
Rod Dia.: 3/16"
GM '78 - UP
Box Qty. 50

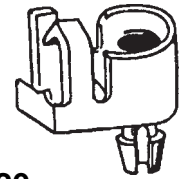

495220
20008799
Door Lock Rod End Clip
Rod Dia.: 5/32"
140 Panel Range
GM '78 - UP
Box Qty. 50

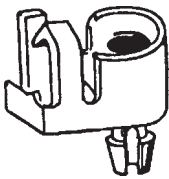

495230
20007898
Door Lock Rod End Clip
Rod Dia.: 5/32"
80 Panel Range
GM '78 - UP
Box Qty. 50



495260
20158344
Door Lock Rod Clip (RH)
GM '79 - UP
Box Qty. 50

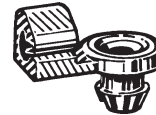

495285
20633148, 20582532
Orange Plastic
Door Lock Rod End Clip
Right Hand
GM '86 - UP
Box Qty. 25



495290
20633149
White Plastic
Door Lock Rod End Clip
Left Hand
GM '86 - UP
Box Qty. 25

GM GLASS SHOP SUPPLIES

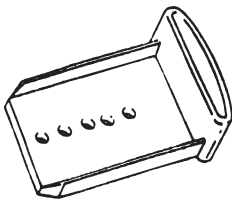

435351
Support, Windshield Glass
Plastic 5 Holes
Universal Use
G.M. Products
Box Qty. 10



450010
4657731
Reveal Clip Early Model
Rear Window
Moulding Fastener
GM Cars
Box Qty. 50

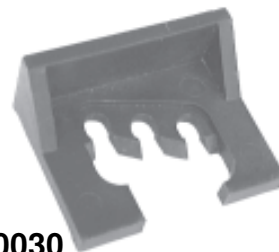

450030
20173225
Plastic
Back Glass Locating Clip
GM "B" Bodies '80 - UP
Box Qty. 50



450120
1654048
Rear Window Reveal
Moulding Fastener
GM Cars
Box Qty. 50

GM

GM GLASS SHOP SUPPLIES

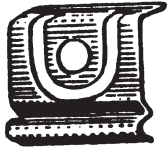

450125
Windshield Reveal
Moulding Clip
Rubberless Installation
GM '75 - '87
Box Qty. 50



450140
4506041
Windshield, Rear Window,
Station Wagon
Quarter Window
Slip On Clip
GM
Box Qty. 100



450220
9895598
Windshield Reveal
Moulding Fastener
GM '71 - '83
Box Qty. 100



450230
*9662950, 9606232,
20603072*
Windshield & Rear Window
Moulding Fastener
GM Cars '73 - UP
Box Qty. 100



450270
4005540, 9731301
Nylon
Windshield Reveal
Moulding Fastener
GM Cars & AMC
'75 - 'UP
Box Qty. 50



450290
1654047
Windshield Reveal
Moulding Clip
GM '74 - UP
Box Qty. 50

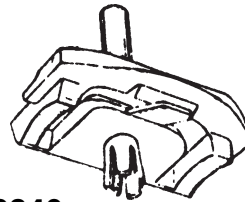

450340
20113224
Plastic
Windshield Reveal
Moulding Clip
GM '79 - UP
Box Qty. 50

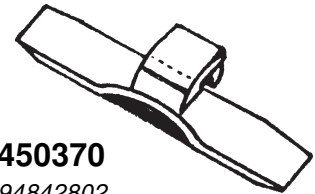

450370
94842802
Orange Plastic
Windshield Reveal
Moulding Clip
Self Adhesive
GM Nova '85 - UP
Box Qty. 10



450380
20169887
Rear Window & Upper Side
Reveal Moulding Clip
Buick, Olds, Cutlass
'88 - '98
Box Qty. 50

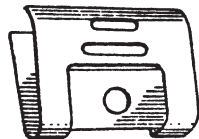

450400
Windshield Reveal
Moulding Clip
Chevy Corvette '64 - '67
Box Qty. 25



450410
20291150
Plastic
Reveal Mldg. / Back Glass
Moulding Clip
GM '82 - UP
Box Qty. 25

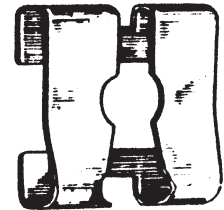

475110
452715
Window Regulator to
Channel Retainer Clip
GM Cars '65 - '71
Box Qty. 50



480010
Door Inside Handle
Retaining Clip,
Door & Quarter Regulator
Handle
Ford, GM Cars
Box Qty. 100



480030
Door Inside Handle
Retaining Clip
"Square Wire"
GM, Ford
Box Qty. 100

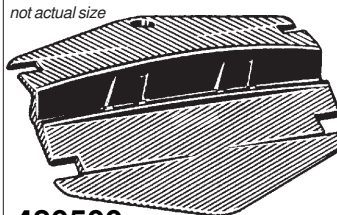

480500
20123070, 20328600
Front Door Window Guide
GM '80 - UP
Buick, Cadillac,
Olds "B", "C" & "X" Bodies
Box Qty. 25

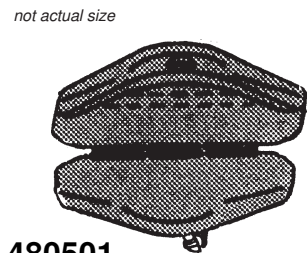

480501
10087223
Plastic Front Door
Window Guide (Rear)
Chevrolet Corsica '87 - UP
Box Qty. 25

GM

GM GLASS SHOP SUPPLIES

not actual size

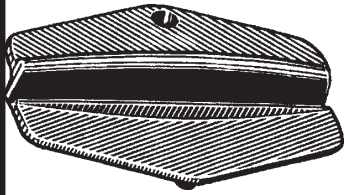

480510
20160591
Rear Door Window Guide
GM Wagons "B", "C",
& "X" Bodies '80 - UP
Box Qty. 25

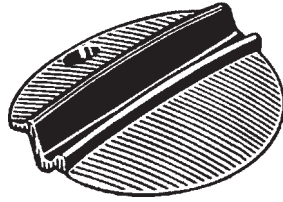

480511
20345381
Plastic Rear Door
Window Guide
GM "J" Bodies '82 - UP
Box Qty. 25

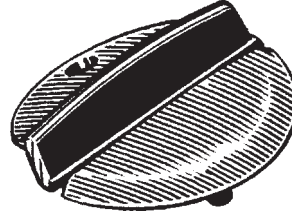

480512
20477850
Plastic Rear Door
Window Guide
GM "C" Bodies '85 - UP
Box Qty. 25

not actual size

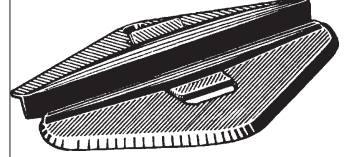

480513
20487630
Plastic Guide Front Door
Window Guide
GM Olds & Buick
"C" Bodies '85 - UP
Box Qty. 25

not actual size

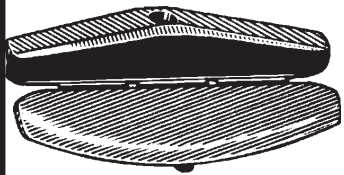

480514
20478733
Plastic Front Door
Window Guide (Rear)
GM Olds & Buick
"C" Bodies '85 - UP
Box Qty. 25

not actual size

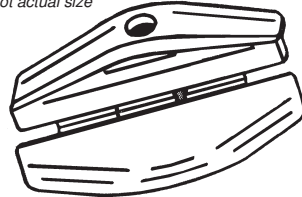

480516
20478732
Plastic Front Door
Window Guide
GM Cars Type "C" & "H"
Body '85 - UP
Box Qty. 10

not actual size

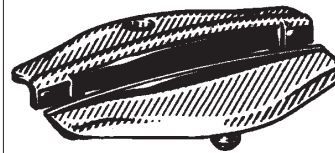

480517
20162174
Plastic Front Door
Window Guide
GM Cars Type "J" Body
'82 - UP
Box Qty. 10

not actual size

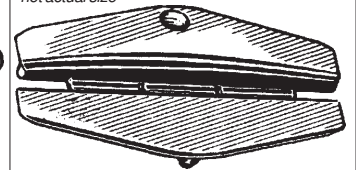

480518
20493450
Plastic Rear Door Window
Guide (Upper)
Chevrolet Corsica '87 - UP
Box Qty. 25

GM

not actual size

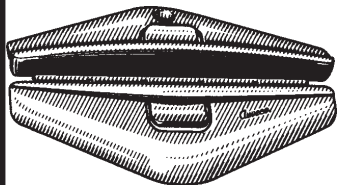

480519
20747508, 20487631
Plastic Front Door
Window Guide
GM "C" Bodies '85 - UP
Box Qty. 25

not actual size

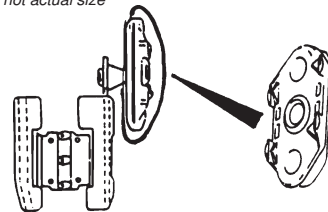

480524
Plastic Guide Front Door
Window Regulator
Guide Only (No Stud)
GM '85 - UP
Box Qty. 5

not actual size

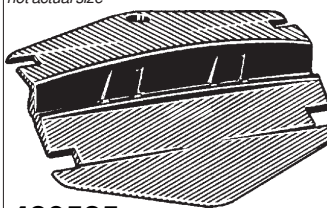

480525
10051034, 10114597
Plastic Front Door Window
Guide
w/Adhesive Gasket
GM "A" Bodies & "S" Trucks
Box Qty. 10

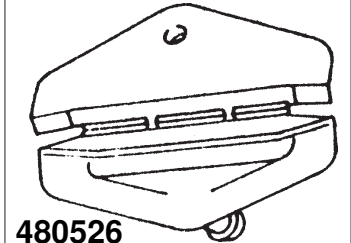

480526
115647709
Plastic
Rear Side Door
Window Guide
GM S-10 Blazer 4 Dr.
Box Qty. 15

480530

20085730
Guide for Tape
Controlled Window
Regulators
(Right Hand)
GM '80 - UP
Box Qty. 10

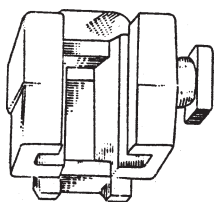

not actual size

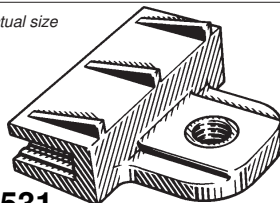

480531
69951-12180
Plastic
Door Window Bracket
w/M6-1.0 Steel Insert.
Imports & Various
Domestic Vehicles
Box Qty. 5

480545

10142872
Plastic Front Door
Window Guide
GM "A" Bodies '90 - UP
Box Qty. 10



480550

20085729
Tape Control Window
Regulator Block
GM '80 - UP
Box Qty. 25

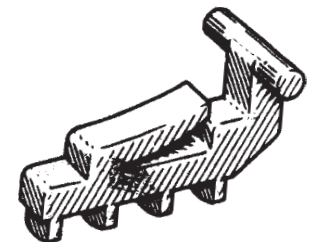

GM GLASS SHOP SUPPLIES

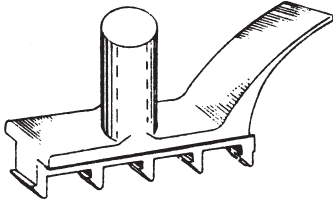

480560
20177186
Tape Control Window
Regulator Block
Cadillac Seville '80 - UP
Box Qty. 10



480578
Upper Ventilator Pivot
Shoulder Rivet
GM Cars '691 - 72
Box Qty. 25



480580
Ventilator Window Handle
Bracket & Shaft
Right Hand
GM '71 - UP
Box Qty. 1



480585
Ventilator Window Handle
Bracket & Shaft
Left Hand
GM '71 - UP
Box Qty. 1

GM



485046
9723881
Window Regulator
Roller and Pin
GM '74 - UP
Box Qty. 10



485430
20148255
Door Window Roller
6mm Shaft
GM '79 - UP
Box Qty. 5



485440
20213450
Steel
Door Glass Roller Nut
6mm Thread Size
GM '79 - UP
Box Qty 25

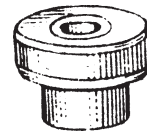

485450
9666748
Window Regulator Roller
GM '72 - UP
Box Qty. 25

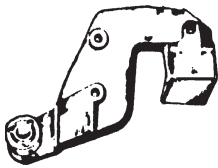

485470
7682223
Left Front Window
Guide Plate (Rear)
GM Full Size Sport
Coupes & Convertibles
Box Qty. 1

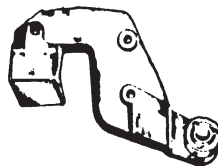

485480
7682226
Right Front Window
Guide Plate (Rear)
GM Full Size Sport
Coupes & Convertibles
Box Qty. 1

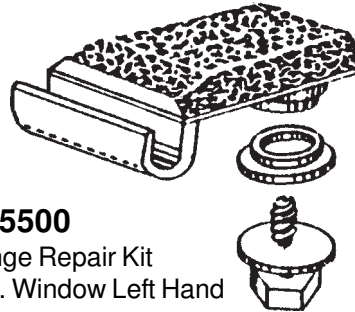

485500
Hinge Repair Kit
Qtr. Window Left Hand
(2 sets used per car)
Chevrolet Chevette,
T-1000 '78 - UP
Box Qty. 6



485501
Hinge Repair Kit
Qtr. Window Right Hand
(2 sets used per car)
Chevrolet Chevette,
T-1000 '78 - UP
Box Qty. 6

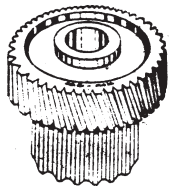

486070
Power Window
Motor Gear
GM '80 - UP
Box Qty. 1

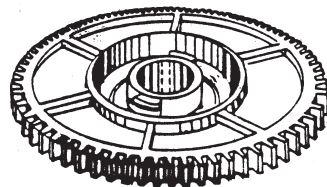

486080
Power Window Motor Gear
GM '80 - UP
Box Qty. 1

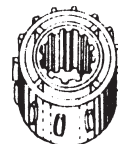

486090
20111709
Gear for Tape Controlled
Window Regulators
GM Cars "B" & "X" Bodies
'80 - UP
Box Qty. 10

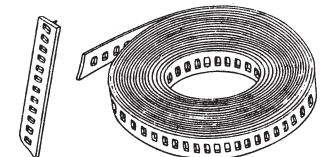

486100
20435391, 20161228
Window Regulator
Elastomeric Tape Provides
Strength & Flexibility
GM '80 - UP
Box Qty. 1