

# SOLDERLESS TERMINALS

Electrical

## 22-18 WIRE RANGE - RED

Vinyl Insulated, Funnel Entry



**395010**  
Stud Size #4-#6  
Box Qty. 100



**395020**  
Stud Size #8-#10  
Box Qty. 100



**395120**  
Stud Size #4-#6  
Box Qty. 100



**395130**  
Stud Size #8-#10  
Box Qty. 100

**395171 Box 500**

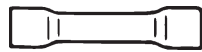

**395170**  
Butt Connector  
Box Qty. 100



**395460**  
*Mates with #395370*  
Snap Plug  
Box Qty. 50



**395370**  
*Mates with #395460*  
Snap Plug Receptacle  
Box Qty. 50



**395410**  
Female Quick-Disconnect  
7/64" (.11") Tab Width  
Box Qty. 50



**395247**  
Male Quick-Disconnect  
1/4" Tab Width  
Box Qty. 25



**395402**  
Female Quick-Connect  
3/16" (.187) Tab Width  
Box Qty. 25



**395401**  
Male Quick-Connect  
3/16" (.187) Tab Width  
Box Qty. 25

## 16-14 WIRE RANGE - BLUE

Vinyl Insulated, Funnel Entry



**395040**  
Stud Size #4-#6  
Box Qty. 100



**395050**  
Stud Size #8-#10  
Box Qty. 100

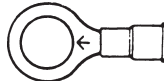

**395060**  
Stud Size #12-1/4"  
Box Qty. 100

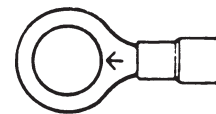

**395065**  
Stud Size 5/16"-3/8"  
Box Qty. 100



**395140**  
Stud Size #4-#6  
Box Qty. 100

**395181 Box 500**



**395150**  
Stud Size #8-#10  
Box Qty. 100

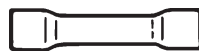

**395180**  
Butt Connector  
Box Qty. 100



**395220**  
*Mates with #395360*  
Snap Plug  
Box Qty. 100



**395360**  
*Mates with #395220*  
Snap Plug Receptacle  
Box Qty. 50



**395403**  
Male Quick-Disconnect  
3/16" (.187) Tab Width  
Box Qty. 25



**395404**  
Female Quick-Disconnect  
3/16" (.187) Tab Width  
Box Qty. 50



**395230**  
Male Quick-Disconnect  
1/4" Tab Width  
Box Qty. 100



**395240**  
Female Quick-Disconnect  
1/4" Tab Width  
Box Qty. 100

# SOLDERLESS TERMINALS

## 12-10 WIRE RANGE - YELLOW

Vinyl Insulated, Funnel Entry

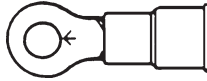

**395070**  
Stud Size #8-#10  
Box Qty. 100

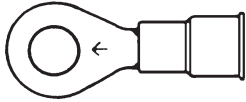

**395080**  
Stud Size #12-1/4"  
Box Qty. 100

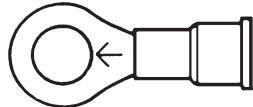

**395090**  
Stud Size 1/4"-5/16"  
Box Qty. 100

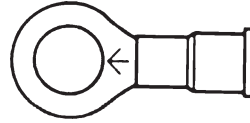

**395100**  
Stud Size 5/16"-3/8"  
Box Qty. 100

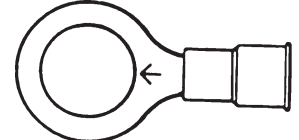

**395110**  
Stud Size 7/16"-1/2"  
Box Qty. 100

Electrical

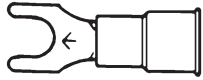

**395160**  
Stud Size #8-#10  
Box Qty. 100

**395191 Box 500**



**395190**  
Butt Connector  
Box 100



**395245**  
Female Quick-Disconnects  
1/4" Tab Width  
Box Qty. 50



**395246**  
Male Quick-Disconnects  
1/4" Tab Width  
Box Qty. 50

## BUTT-CONNECTORS

Nylon Insulated



**396170**  
"CLEAR RED"  
22-18 Gauge Wire  
Box Qty. 50



**396180**  
"CLEAR BLUE"  
16-14 Gauge Wire  
Box Qty. 50



**396190**  
"CLEAR YELLOW"  
12-10 Gauge Wire  
Box Qty. 50

## QUICK-CONNECTS

Fully Insulated Nylon, 1/4" Tab Width



**Female**

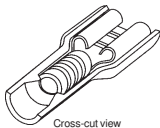

**395490**  
"CLEAR RED"  
22-18 Gauge Wire  
Box Qty. 50

**395480**  
"CLEAR BLUE"  
16-14 Gauge Wire  
Box Qty. 50

**395501**  
"CLEAR YELLOW"  
12-10 Gauge Wire  
Box Qty. 50

**Male**

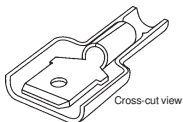

**395500**  
"CLEAR RED"  
22-18 Gauge Wire  
Box Qty. 50

**395470**  
"CLEAR BLUE"  
16-14 Gauge Wire  
Box Qty. 50

**395502**  
"CLEAR YELLOW"  
12-10 Gauge Wire  
Box Qty. 50

# SOLDERLESS TERMINALS

## QUICK-LOCK CONNECTOR

Self Stripping, Connects and Insulates

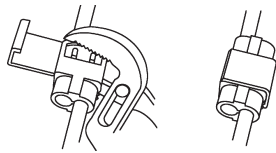
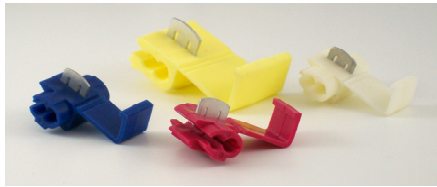

Prod No.	Description	Box Qty.
<b>395195</b>	22-18 Ga. Wire, "Red"	50
<b>395199</b>	18-14 Ga. Wire, "White"	50
<b>395200</b>	16-14 Ga. Wire, "Blue"	50
<b>395201</b>	16-14 Ga. Wire, "Blue"	250
<b>395205</b>	12-10 Ga. Wire, "Yellow"	50

## T - TYPE WIRE TAP

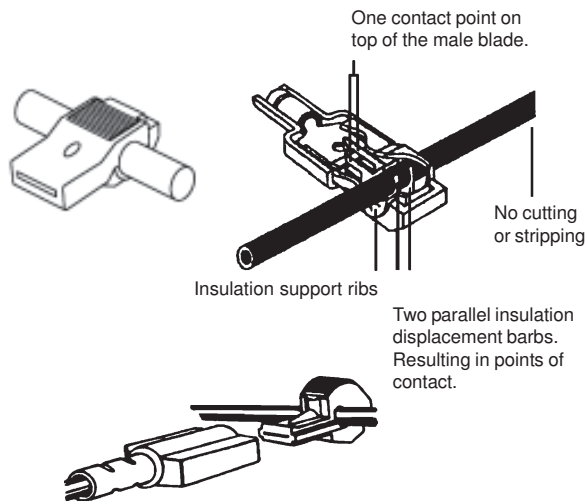

This Tap makes tapping into an existing wire quick, easy and reliable. This Tap actually is a fully insulated female quick disconnect that can be spliced onto a wire and then mated with a .250 size male disconnect. All without stripping, twisting or soldering.

Wire Size	Color Code	Tab Size	Product No. 10 per pkg.	Product No. 50 per pkg.
22-18	Red	.250	<b>395512</b>	<b>395513</b>
18-14	Blue	.250	<b>395510</b>	<b>395511</b>
12-10	Yellow	.250	<b>395514</b>	<b>395515</b>

## Simple Installation

Select the correct splice size for the wire gauge. Strip the wires 0.3" (7.6mm) from the end and insert into the crimp barrel.



Making sure the wire end is properly seated, make the crimp connection using a tool designed for insulated splices.



Apply heat directly to the splice, working from the center out to the edges, using a hot air gun or other heat source, until the tubing shrinks and the adhesive flows. Allow to cool before inspecting splice and checking the integrity.



## PERMA-SEAL NYLON HEAT SEALABLE BUTT CONNECTORS

(With Adhesive Liner For Moisture Resistance)

Perma-Seal Connectors provide ideal protection from moisture intrusion for exposed wiring on Automobiles, Fleet Vehicles, R.V.'s, Trailers and Motorcycles. As connector is heated and begins to shrink, the adhesive liner melts and flows to encapsulate the connection.

Wire Size	Color	Product No. 10 per pkg.	Product No. 50 per pkg.
22-18	Red	<b>396175</b>	<b>396177</b>
16-14	Blue	<b>396185</b>	<b>396186</b>
12-10	Yellow	<b>396195</b>	<b>396196</b>

# SOLDER SPLICE CONNECTORS / MISC.

## SOLDER SPLICE CONNECTORS

Our Solder Splice Connectors consist of a fluxed solder ring with a heat shrinkable insulation sleeve, when heated, provide a completely soldered, strain relieved, and encapsulated connection.

- \* Clear insulation sleeve for easy inspection.
- \* UL recognized.
- \* One-piece design makes installation easy!
- \* Temperature rating: -55° C to 125° C
- \* Minimum shrink temperature: 149° C (300° F)
- \* Meets or exceeds the requirements of UL486A.

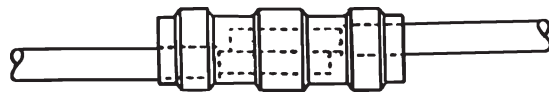
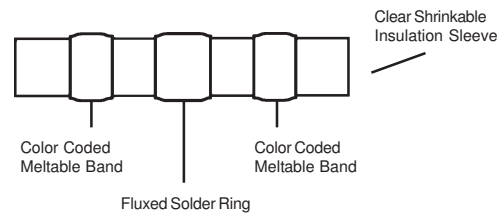

### Installation:

1. Wire sizes from 26AWG to 18AWG strip 3/8" of insulation. All other size wires strip 1/2" of insulation.
2. Position the wire strands into the Solder Splice connector so that they overlap and are centered in the solder ring, See above. (the easiest method is to lay the splice connection down on a flat, heat resistant surface, then follow step 3.)
3. Apply heat, using an appropriate heat gun, directly to the solder ring until it melts, forming a solder joint. Then move the heat back & forth so that the insulation sleeve is completely shrunk.

*NOTE: If the connection cannot be laid down on a flat surface, an alternate method would be to overlap the stripped wire & center in the solder ring. With your thumb & forefinger, pinch the solder ring so it deforms over the wires, this holding them in place. Then apply the heat.*

Product Number	Color Code	Maximum Inside Dia.	Length (L) Approx.
397170.....	Red.....	.110.....	1.5
397180.....	Blue.....	.175.....	1.5
397190.....	Yellow.....	.230.....	1.5

Electrical

## MISCELLANEOUS



**394010**  
"Red"  
8 ga. Wire Size  
Butt Connector  
Vinyl Insulated  
Box Qty. 10



**396023**  
16-14 Gauge Wire Size  
Non-insulated  
Butt Connector Krimptite  
Butted Seam Barrel  
Box Qty. 25



**396024**  
12-10 Gauge Wire Size  
Non-insulated  
Butt Connector Krimptite  
Butted Seam Barrel  
Box Qty. 25

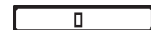

**396025**  
22-18 Gauge Wire  
Non-insulated  
Butt Connector  
Box Qty. 100

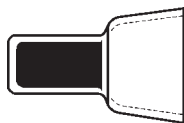

Nylon Insulated  
Closed End Connectors

**396210**  
22-12 Gauge  
Box Qty. 50

**396215**  
16-10 Gauge  
Box Qty. 50

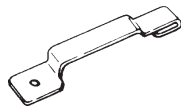

**395435**  
*Can be used with #395410*  
Blade Type Fuse Tap  
For Quick Connect & Disconnect of  
Accessories, for ATO or ATC Fuses,  
Installed in Fuse Block  
Box Qty. 25

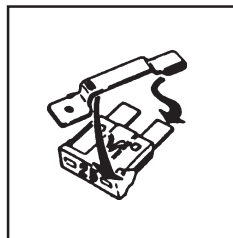

**395436**  
*Can be used with #395410*  
Mini Fuse Blade Type  
Fuse Tap  
For Tapping "Hot Side" of  
Mini Fuse Type Fuse Block  
Box Qty. 50

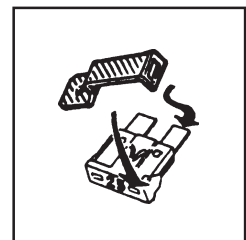

# ELECTRALINK TERMINALS

## Electralink - "Sealed for Superiority"

Electralink is the clear choice of professionals that demand a superior electrical connection. Soldered connections facilitate maximum current flow with minimal resistance, provide exceptional tensile strength, and prevent reverse plating. However, with the advent of crimp connections and their ease of use, the popularity of soldering declined. Electralink has once again made soldering a viable option by providing a high quality, sealed solder connection that takes the guesswork out of installation.

These connectors require the installer to insert the stripped wire(s) into the solder barrel; Apply heat to the shrink tubing; Concentrate the heat source on the solder barrel after shrinking the tubing; When the solder flows through the wire strands, remove the heat and let the terminal cool.

Tubing will shrink to completely seal the entire connection, protecting the connection from moisture, vibration, strain and unnecessary flexing.

### KEY FEATURES & BENEFITS

**Translucent, adhesive-lined polyolefin tubing**

*Allows visual inspection, prevents corrosion & provides a waterproof seal!*

**Easy installation with pre-measured solder**

*Takes the guesswork out of the soldering process!*

**A soldered electrical connection**

*Provides superior current flow and tensile strength!*



### RING TERMINALS

Description	10 Pkg. Prod. #	50 Pkg. Prod. #
18-20 AWG #6 Stud .....	<b>399010</b> .....	<b>399011</b>
18-20 AWG #8 Stud .....	<b>399015</b> .....	<b>399016</b>
18-20 AWG #10 Stud .....	<b>399020</b> .....	<b>399021</b>
18-20 AWG 1/4" Stud .....	<b>399025</b> .....	<b>399026</b>
14-16 AWG #8 Stud .....	<b>399030</b> .....	<b>399031</b>
14-16 AWG #10 Stud .....	<b>399035</b> .....	<b>399036</b>
14-16 AWG 1/4" Stud .....	<b>399040</b> .....	<b>399041</b>
14-16 AWG 3/8" Stud .....	<b>399045</b> .....	<b>399046</b>
10-12 AWG #10 Stud .....	<b>399050</b> .....	<b>399051</b>
10-12 AWG 1/4" Stud .....	<b>399055</b> .....	<b>399056</b>
10-12 AWG 3/8" Stud .....	<b>399060</b> .....	<b>399061</b>
10-12 AWG 1/2" Stud .....	<b>399065</b> .....	<b>399066</b>

# ELECTRALINK TERMINALS

## SPADE TERMINALS



Description	10 Pkg. Prod. #	50 Pkg. Prod. #
18-20 AWG #10 Stud .....	<b>399070</b>	<b>399071</b>
14-16 AWG #10 Stud .....	<b>399075</b>	<b>399076</b>
10-12 AWG #10 Stud .....	<b>399080</b>	<b>399081</b>

## BUTT TERMINALS



Description	10 Pkg. Prod. #	50 Pkg. Prod. #
22-24 AWG .....	<b>399085</b>	<b>399086</b>
18-20 AWG .....	<b>399090</b>	<b>399091</b>
14-16 AWG .....	<b>399095</b>	<b>399096</b>
10-12 AWG .....	<b>399100</b>	<b>399101</b>

## SLIP-ON CONNECTORS

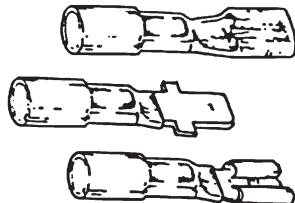

Description	10 Pkg. Prod. #	50 Pkg. Prod. #
18-20 AWG .250 Fully Insulated Female .....	<b>399105</b>	<b>399106</b>
18-20 AWG .250 Fully Insulated Male .....	<b>399110</b>	<b>399111</b>
14-16 AWG .250 Female .....	<b>399115</b>	<b>399116</b>
14-16 AWG .250 Fully Insulated Female .....	<b>399120</b>	<b>399121</b>
14-16 AWG .250 Male .....	<b>399125</b>	<b>399126</b>

## Krimpa-Seal - "Sealed for Quality"

Our enhanced Krimpa-Seal product line is the finest line of "crimp-and-seal" connectors on the market today. New design features, the use of only the finest components, and an expanded product selection, place Krimpa-Seal squarely at the top of the class. Our line provides a quick, effective sealed connection in applications where crimping is preferred. In just a few easy steps, Krimpa-Seal will prevent corrosion and contamination in your critical wiring applications.

These connectors require the installer to insert the stripped wire(s) into the connector barrel. Using a crimping tool, crimp the barrel to the wire. Apply heat to the connector to shrink and activate sealer.

Tubing will shrink and release a sealer to completely seal the entire connection, protecting the connection from moisture, vibration, strain and unnecessary flexing.

### KEY FEATURES & BENEFITS

**Seamless butt connectors & brazed seam rings and spades**

*Prevents opening of connector barrel!*

**Color-coded tubing with wire gauge imprint**

*Provides easy identification of the correct part for the job!*

**Conforms to automotive manufacturers' specifications for wiring repairs**

*Necessary for maintaining electrical warranties!*



### RING TERMINALS

Description	10 Pkg. Prod. #	50 Pkg. Prod. #
18-20 AWG #6 Stud .....	<b>398010</b> .....	<b>398011</b>
18-20 AWG #8 Stud .....	<b>398015</b> .....	<b>398016</b>
18-20 AWG #10 Stud .....	<b>398020</b> .....	<b>398021</b>
18-20 AWG 1/4" Stud .....	<b>398025</b> .....	<b>398026</b>
14-16 AWG #8 Stud .....	<b>398030</b> .....	<b>398031</b>
14-16 AWG #10 Stud .....	<b>398035</b> .....	<b>398036</b>
14-16 AWG 1/4" Stud .....	<b>398040</b> .....	<b>398041</b>
14-16 AWG 3/8" Stud .....	<b>398045</b> .....	<b>398046</b>
10-12 AWG #10 Stud .....	<b>398050</b> .....	<b>398051</b>
10-12 AWG 1/4" Stud .....	<b>398055</b> .....	<b>398056</b>
10-12 AWG 3/8" Stud .....	<b>398060</b> .....	<b>398061</b>
10-12 AWG 1/2" Stud .....	<b>398065</b> .....	<b>398066</b>

# KRIMPA-SEAL TERMINALS

## SPADE TERMINALS



Description	10 Pkg. Prod. #	50 Pkg. Prod. #
18-20 AWG #10 Stud .....	<b>398070</b>	<b>398071</b>
14-16 AWG #10 Stud .....	<b>398075</b>	<b>398076</b>
10-12 AWG #10 Stud .....	<b>398080</b>	<b>398081</b>

## BUTT CONNECTORS



Description	10 Pkg. Prod. #	50 Pkg. Prod. #
22-24 AWG .....	<b>398085</b>	<b>398086</b>
18-20 AWG .....	<b>398090</b>	<b>398091</b>
14-16 AWG .....	<b>398095</b>	<b>398096</b>
10-12 AWG .....	<b>398100</b>	<b>398101</b>
8 AWG .....	<b>398105</b>	<b>398106</b>

## SLIP-ON CONNECTORS

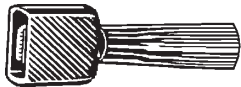

Description	10 Pkg. Prod. #	50 Pkg. Prod. #
14-16 AWG .250 Fully Insulated Female .....	<b>398110</b>	<b>398111</b>
14-16 AWG .250 Fully Insulated Male .....	<b>398115</b>	<b>398116</b>

## BULLET PLUG & RECEPTACLES



Description	10 Pkg. Prod. #	50 Pkg. Prod. #
14-16 AWG .157 diameter plug .....	<b>398120</b>	<b>398121</b>
14-16 AWG .157 diameter receptacle .....	<b>398125</b>	<b>398126</b>



### 96401

Self Adjusting  
Stripping & Crimping Tool  
*Features self-adjusting strip  
mechanism with spring action.*  
Box Qty. 1



# HEAT SHRINK TUBING

## POLYOLEFIN THIN WALL HEAT SHRINK TUBING

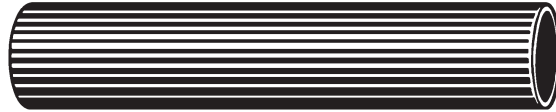

A thin wall high quality tubing with a wide variety of uses. It is made from flame retarded polyolefin, providing excellent physical, chemical and electrical properties that meet industrial & military requirements for highly reliable shrink tubing. Meets MIL-1-23053/5, UL and CSA Specifications.

Shrink ratio: 2:1

Minimum shrink Temperature: 121 °C

Continuous operating temperature: -55 °C to 135 °C

Product Number	Expanded Diameter	Reduced Diameter	Length	Color	Box Qty.
48010	3/16"	3/32"	4"	Black	12
48015	1/4"	1/8"	4"	White	12
48016	3/8"	3/16"	4"	Red	6
48017	1/2"	1/4"	4"	Black	6
48018	3/4"	3/8"	4"	White	6
48019	1"	1/2"	4"	Red	4

## PERM-FIT DUAL WALL HEAT SHRINK TUBING (WITH ADHESIVE MELT LINER)

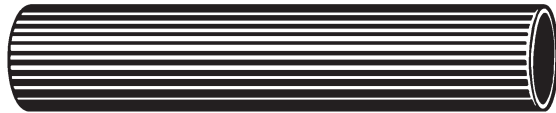

This PERM-FIT dual-wall polyolefin heat shrink tubing has an adhesive melt liner which offers excellent resistance to vibration, abrasion and corrosion while providing superior strain relief. As the tubing shrinks, the adhesive liner melts and flows to seal and encapsulate components or splices contained within.

Meets MIL-1-23053/4 & UL224 Requirements (jacket only).

Shrink ratio: 3:1

Minimum shrink temperature: 125 °C

Continuous operating temperature: -30 °C to 110 °C

Product Number	Expanded Dia.	Reduced Dia. (approx.)	Length	Color	Box Qty.
48020	1/8"	3/64"	4"	Black	12
48021	3/16"	1/16"	4"	Black	12
48025	1/4"	5/64"	4"	Black	12
48026	3/8"	1/8"	4"	Black	6
48040	1/8"	3/64"	12"	Black	12
48041	1/8"	3/64"	12"	Red	12
48042	3/16"	1/16"	12"	Black	12
48043	3/16"	1/16"	12"	Red	12
48044	1/4"	5/64"	12"	Black	12
48045	1/4"	5/64"	12"	Red	12
48046	3/8"	1/8"	12"	Black	12
48047	3/8"	1/8"	12"	Red	12
48048	1/2"	11/64"	12"	Black	12
48049	1/2"	11/64"	12"	Red	12
48050	3/4"	1/4"	12"	Black	12
48051	3/4"	1/4"	12"	Red	12

# PRIMARY WIRE

## Primary Wire

General Purpose  
 Standard PVC Insulation (SAE/GPT Type)  
 Suitable for Most Automotive Applications  
 Abrasion Resistant and Impervious to Oil,  
 Grease and Diesel fumes.

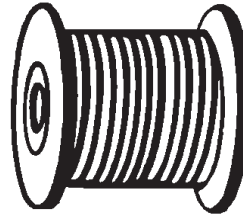

Gauge	Stranding	O.D.	Product Number 100 ft. Spools						
			Black	Blue	Green	Red	White	Yellow	Orange
18	16 x 30	.092	<b>1101</b>	<b>1102</b>	---	<b>1104</b>	<b>1105</b>	---	---
16	19 x 29	.104	<b>1111</b>	<b>1112</b>	<b>1113</b>	<b>1114</b>	<b>1115</b>	<b>1116</b>	<b>1117</b>
14	19 x 27	.117	<b>1121</b>	<b>1122</b>	<b>1123</b>	<b>1124</b>	<b>1125</b>	<b>1126</b>	---
12	19 x 25	.142	<b>1131</b>	<b>1132</b>	---	<b>1133</b>	<b>1134</b>	---	---
10	19 x 23	.175	<b>1141</b>	---	---	<b>1142</b>	<b>1143</b>	---	---

The lower the gauge number, the thicker the wire. (10 gauge is thicker than 16 gauge)

Electrical

## Speaker Wire

Product No. **1170**  
 100 Ft. Spool



*Audio Cable Heavy-Duty Zip Cord (Color: Clear)*

Construction: One conductor tinned copper, one conductor bare copper for polarity identification. PVC insulation, identifying ridge on one conductor, conductors laid parallel rip-type construction for easy separation of conductors when split apart.

## Bonded Parallel Wire

RoHS compliant • All Copper Strand core •  
 Designed especially for RV's and boat utility trailers •  
 For use at 60 volts or less • Conductors meet SAE J1128 specs •  
 Temp rating 80°C/176°F • Nominal cold temp rating -30°C/-22°F  
 100 Ft. Roll



Prod No.	Ga.	Color
<b>1190</b>	16/2 ga.	Red/Black
<b>1191</b>	14/2 ga.	Red/Black

## Spooled Fusible Link Wire

A fusible link is a special section of low tension wire installed by an OEM and designed to open a circuit when subjected to extreme current overload. Its purpose is to minimize wiring system damage when such an overload accidentally occurs in those circuits protected by the fusible link. Our fusible link wire meets the requirements of SAE J-156 and the insulation has the characteristics as listed for SAE J-1128 type SXL. The vehicle manufacturer should be consulted about questions on fusible link length and size. Typically fusible link wire should be 4 gauges smaller than the circuit wire.

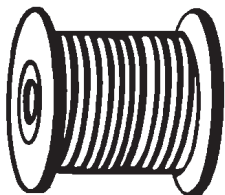

Pkg Qty.: one 25' spool

Prod. No.	Gauge	Color	Replaces
<b>1171</b> .....	18 .....	Green .....	GM:6293702
<b>1172</b> .....	16 .....	Red .....	GM:6292996
<b>1173</b> .....	14 .....	Red .....	GM:6292995
<b>1174</b> .....	12 .....	Blue .....	-----
<b>1175</b> .....	10 .....	Orange .....	-----

## Rosin Core Thin Wire Solder

Very effective for general electrical soldering. Comes in a convenient reusable container that fits right in your pocket! Contains 40% Tin / 60% Lead Solder and has a rosin flux core.

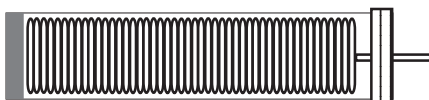

Dia.: .062"  
 Net Wt.: .90 oz.  
 Melting Point: 460°F

	1 Bx Qty	5 Bx Qty
Prod. Number .....	<b>97303</b>	<b>97304</b>

## NATURAL COLOR CABLE TIES

100 % VIRGIN NYLON 6/6  
U.L., QPL LISTED  
MIL SPECIFICATION



Rounded edges reduce insertion force and surface abrasion.  
Ridges on tip allow firmer grip for pull thru.  
Reinforced neck for greater strength.  
Advance pawl design for superior locking power.  
Low profile head for streamline appearance and snag resistance.  
Smooth edges do not cut insulation.

Approx. Length	Bundle Diameter	Tensile Strength	Product No. 100 Pack	Product No. 1000 Pack
4" .....	1/16" - 3/4" .....	18 lbs. ....	<b>58001</b> .....	<b>58002</b>
8-1/2" .....	1/16" - 2" .....	40 lbs. ....	<b>58003</b> .....	<b>58004</b>
14" .....	1/16" - 4" .....	50 lbs. ....	<b>58005</b> .....	<b>58006</b>

## U.V. BLACK COLOR CABLE TIES

SAME FEATURES AS ABOVE ONLY THE COLOR IS BLACK AND IS ULTRAVIOLET RESISTANT.



Approx. Length	Bundle Diameter	Tensile Strength	Product No. 100 Pack	Product No. 1000 Pack
4" .....	1/16" - 3/4" .....	18 lbs. ....	<b>58018</b> .....	<b>58019</b>
8-1/2" .....	1/16" - 2" .....	40 lbs. ....	<b>58014</b> .....	<b>58015</b>
14" .....	1/16" - 4" .....	50 lbs. ....	<b>58016</b> .....	<b>58017</b>



**Heavy Duty**  
Black Nylon Cable Ties  
Self Clamping

### 58023

Tensile Strength: 50 lbs.  
Length: 11"  
Width: 3/16"  
Box Qty. 50

### 58025

Tensile Strength: 120 lbs.  
Length: 14"  
Width: 5/16"  
Box Qty. 25

## NATURAL COLOR SCREW MOUNT CABLE TIES

SAME FEATURES AS THE ABOVE NATURAL COLOR TIES BUT HAS A MOULDED-IN #10 SIZE SCREW MOUNT



Approx. Length	Bundle Diameter	Tensile Strength	Product No. 100 Pack	Product No. 1000 Pack
7-1/2" .....	1/16" - 1-3/4" ...	50 lbs. ....	<b>58010</b> .....	<b>58011</b>
14-1/2" .....	1/16" - 2" .....	50 lbs. ....	<b>58012</b> .....	<b>58013</b>

### 58020

White Nylon  
Cable Tie Mount  
Fits Into a 1/4" or 6mm Size Hole  
Accepts up to 3/16" cable ties  
Box Qty. 25



### 58022

Black Nylon  
Cable Tie Mount  
Fits Into a 1/4" or 6mm Size Hole  
Accepts up to 5/16" cable ties  
Box Qty. 25



# WIRE LOOM, CLIPS, STRAPS

## WIRE LOOM

(SPLIT FLEXIBLE TUBING)

Nylon 6 Black  
Maximum Temp. 345°F  
Box Qty. 1



Prod #	I.D.	O.D.	Length
5085	1/4"	3/8"	50'
5087	3/8"	9/16"	50'
5088	3/8"	9/16"	10'
5089	1/2"	11/16"	50'
5090	1/2"	11/16"	10'

## EXPANDABLE ELECTRICAL SLEEVING

A polyethylene terephthale lightweight sleeving used to cover wires, wire bundles, tubing, hoses, trailer chains, outboard motor cables, marine hoses and harness/cable assemblies. Operating temp: -75°C to 125°C (-103°F to 257°F). Manufactured to meet UL, CSA and FMVSS 302 requirements. I.D. size is measured at relaxed state, expands to 2 times original size. Box Qty: 1 Roll

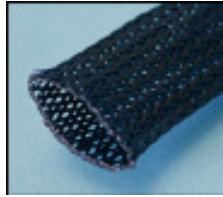

Prod #	I.D.	O.D.	Length
5091	1/4"	3/8"	100'
5092	1/2"	9/16"	100'

Electrical

## Wire Loom Routing Clips for wire loom

(also called split flexible tubing, convoluted conduit)



### 505205

12160858  
Nylon  
Wire Loom  
Routing Clip  
I.D.: 10mm  
O.D.: 13mm  
GM  
Box Qty. 15

Prod #	OEM #	I.D.	O.D.	Box Qty.
505110	8911473	11/32"	1/2"	50
505120	8911497	13/32"	19/32"	50
505130	8911472	1/2"	11/16"	50
505140	8917320	3/4"	1"	50

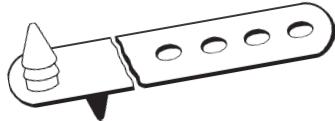

### 505010

Clear Color  
Adjustable Nylon Strap  
5" long  
Box Qty. 25

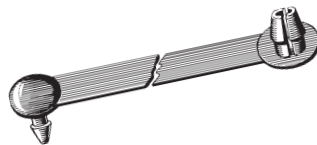

### 505020

Black  
Plastic Harness Strap  
2-3/4" Long  
For a 1/4" hole,  
.115" metal thickness.  
Box Qty. 50



### 505145

Black Nylon  
Wire Loom Clips  
Fits 1/4" Tubing Size  
Push in  
Box Qty. 50



### 505150

Wiring and Tube Clip  
For 1/2" O.D.  
Tube or Wire  
Ford  
Box Qty. 50



### 505170

Wiring and Tube Clip  
For 3/4" O.D.  
Tube or Wire  
Ford  
Box Qty. 50

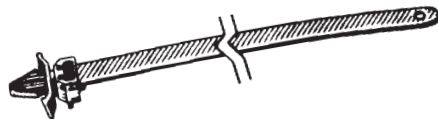

### 505195

9928-91-053,  
90672-SA0-0030  
Releasable Cable Strap  
Length: 5-1/2" (140mm)  
Fits a 7mm Hole  
Mazda & Honda & General Purpose  
Box Qty. 25

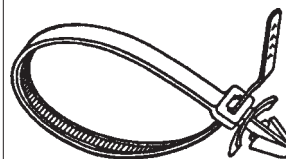

### 505197

Push-Mount Cable Tie  
50 lb. Tensile Strength  
Length: 8"  
Box Qty. 25

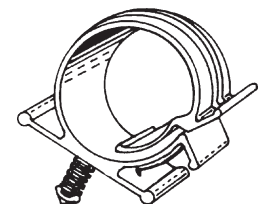

### 505200

20562202  
Wiring Harness Clip  
1-1/2" I.D. x 1-7/8" O.D.  
Fits a 1/4" hole  
GM Cars  
Box Qty. 15

# FUSES

## AUTOMOTIVE GLASS FUSES

PACKAGED 5 FUSES PER BOX



Product Number	Industrial Code	AMP	Size
46001	AGA-1	1	1/4" x 5/8"
46002	AGA-2	2	1/4" x 5/8"
46003	AGA-3	3	1/4" x 5/8"
46005	AGA-10	10	1/4" x 5/8"
46006	AGA-15	15	1/4" x 5/8"
46007	AGA-20	20	1/4" x 5/8"
46008	AGA-25	25	1/4" x 5/8"
46009	AGA-30	30	1/4" x 5/8"
46010	AGC-1-1/2	1-1/2	1/4" x 1-1/4"
46011	AGC-2	2	1/4" x 1-1/4"
46013	AGC-4	4	1/4" x 1-1/4"
46014	AGC-5	5	1/4" x 1-1/4"
46015	AGC-7-1/2	7-1/2	1/4" x 1-1/4"
46016	AGC-10	10	1/4" x 1-1/4"
46017	AGC-15	15	1/4" x 1-1/4"
46019	AGC-25	25	1/4" x 1-1/4"
46020	AGC-30	30	1/4" x 1-1/4"
46021	AGC-35	35	1/4" x 1-1/4"
46022	AGW-3	3	1/4" x 7/8"
46023	AGW-5	5	1/4" x 7/8"
46024	AGW-15	15	1/4" x 7/8"
46025	AGW-20	20	1/4" x 7/8"
46026	AGW-30	30	1/4" x 7/8"
46027	AGX-2	2	1/4" x 1"
46028	AGX-3	3	1/4" x 1"
46029	AGX-20	20	1/4" x 1"
46030	AGX-25	25	1/4" x 1"
46031	AGX-30	30	1/4" x 1"
46036	SFE-4	4	1/4" x 5/8"
46037	SFE-6	6	1/4" x 3/4"
46038	SFE-7-1/2	7-1/2	1/4" x 7/8"
46039	SFE-9	9	1/4" x 7/8"
46040	SFE-14	14	1/4" x 1-1/16"
46041	SFE-20	20	1/4" x 1-1/4"
46042	SFE-30	30	1/4" x 1-7/16"

## AUTOMOTIVE CERAMIC FUSES

PACKAGED 5 FUSES PER BOX



Prod Number	Industrial Code	AMP	Size	Color
46032	GBC-5	5	6mm x 25mm	Yellow
46033	GBC-8	8	6mm x 25mm	White

# FUSES / CIRCUIT BREAKERS

## ATO FUSES

ATO FUSE for  
OEM automotive applications  
1977 & up

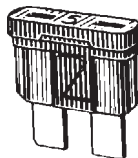

Fuse	AMPS	COLOR	5 Pkg.	25 Pkg.
ATO-3	3	VIOLET	46050	46050-25
ATO-4	4	PINK	46051	46051-25
ATO-5	5	TAN	46052	46052-25
ATO-7.5	7.5	BROWN	46053	46053-25
ATO-10	10	RED	46054	46054-25
ATO-15	15	BLUE	46055	46055-25
ATO-20	20	YELLOW	46056	46056-25
ATO-25	25	WHITE	46057	46057-25
ATO-30	30	GREEN	46058	46058-25
ATO-40	40	ORANGE	46059	46059-25

Electrical

## MINI-FUSES

Replacement fuses for late model  
automotive O.E.M applications.



Fuse	AMPS	COLOR	5 Pkg.	25 Pkg.
MINI-2	2	SMOKE	48102	48102-25
MINI-3	3	VIOLET	48103	48103-25
MINI-4	4	PINK	48104	48104-25
MINI-5	5	TAN	48105	48105-25
MINI-7.5	7.5	BROWN	48107	48107-25
MINI-10	10	RED	48110	48110-25
MINI-15	15	BLUE	48115	48115-25
MINI-20	20	YELLOW	48120	48120-25
MINI-25	25	WHITE	48125	48125-25
MINI-30	30	GREEN	48130	48130-25

## MAXI-FUSES

Used on automotive  
vehicles since 1989  
1 Per Box

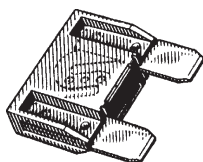

PROD NO.	FUSE NO.	AMPS	COLOR
49020	MAX-20	20	YELLOW
49030	MAX-30	30	GREEN
49040	MAX-40	40	ORANGE
49050	MAX-50	50	RED
49060	MAX-60	60	BLUE



**48031**  
**THERMAL LIMITER SWITCH**  
For GM Air Conditioners  
1 Per Box

## CIRCUIT BREAKER FUSE CLIP TYPE

Fits 1-1/4" fuse clips  
1 Per Box

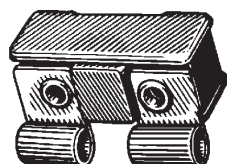

PROD NUMBER	AMP RATING
47010	10
47015	15
47020	20
47025	25
47030	30
47035	35
47040	40

## CIRCUIT BREAKER STUD TYPE

(6-24 volts)  
Conforms to SAE J553  
1 Per Box

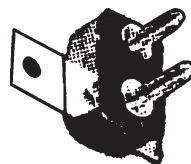

S & R NUMBER	AMP RATING
47115	15
47120	20
47125	25
47130	30
47135	35
47140	40

# CARTRIDGE FUSES



## PAL - FEMALE TYPE AUTO LINK FUSE

1 Per Box

PROD NO.	FUSE NO.	AMP	COLOR
49001	PAL-030	30	PINK
49002	PAL-040	40	GREEN
49007	PAL-050	50	RED
49003	PAL-060	60	YELLOW

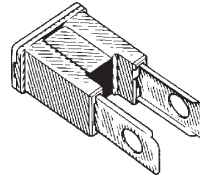

## PAL - MALE TYPE AUTO LINK FUSE

1 Per Box

PROD NO.	FUSE NO.	AMP	COLOR
49004	PAL-130	30	PINK
49005	PAL-160	60	YELLOW
49006	PAL-180	80	BLACK

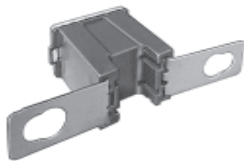

## PAL- 13/16" BENT MALE TYPE AUTO LINK FUSE

1 Per Box

PROD NO.	FUSE NO.	AMP	COLOR
48990	PAL-230	30	PINK
48991	PAL-240	40	GREEN
48992	PAL-250	50	RED
48993	PAL-260	60	YELLOW

## J-CASE FUSES FMX SERIES

Female Fuse  
1 Per Box

PROD NO.	AMP	COLOR
49540	20	LT BLUE
49541	30	PINK
49542	40	GREEN
49543	50	RED
49544	60	YELLOW



Electrical

# FUSEHOLDERS

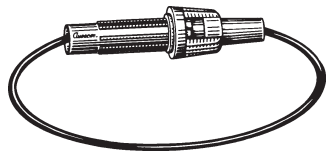

## 48001

Universal Bayonet Knob  
In-line Fuse Holder  
Supplied with a 15" loop of  
14 ga. wire and three springs to  
accommodate SFE 7-1/2,9,14,20,  
AGA, AGW, and AGX fuses.  
Box Qty. 1

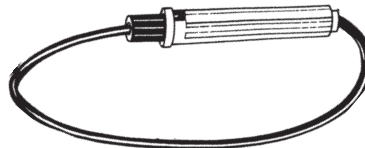

## 48002

Heavy Duty 30 Amp  
In-line Fuse Holder  
Supplied with 2-4" leads of 12 Ga. wire  
AGC 30 amp fuse included  
Box Qty. 1



## 48004

Heavy Duty In-line  
ATO Fuse Holder - Panel Mount Type  
Supplied with an 8" loop of 10 Ga.  
orange wire for use with ATO 25 and  
ATO 30 amp fuses.  
Box Qty. 1

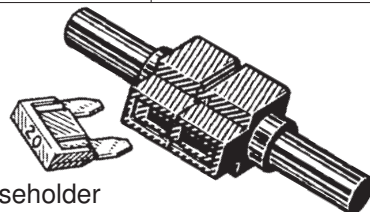

## 48006

Mini-Fuse Easy Crimp Fuseholder  
Use with MINI Blade fuses.  
30 amp max., #10-14 AWG wire.  
Quickly and easily crimps stranded  
copper wire to fuseholder terminals  
using a standard crimping tool.  
Box Qty. 1

## 48007

Water Tight  
Sealed Fuseholder - ATO  
Use with ATO fuses.  
Rated 1-30 amps  
9" 12 ga (3.0mm) Type GXL leads  
Designed for automotive/marine engine compartment  
conditions, and provides the highest reliability in the  
harsh environments.  
Box Qty. 6

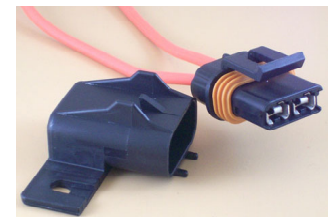

# FLASHERS

## 48550

INDUSTRY #550

Replaces 12-volt, three-terminal flashers.

Flashes two to three 32 C.P. standard or long-life lamps for turn signals.

Flashes two to six lamps for hazard warning.

Box Qty. 1



3-Prong

## 48552

INDUSTRY #536/552

Replaces 12-volt, two-terminal flashers.

Flashes two to three 32 C.P.

Standard or long-life lamps for turn signals.

Flashes two to six lamps for hazard warning.

Box Qty. 1

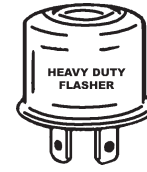

2-Prong

# FUSE ASSORTMENTS

Electrical



## 48600

AUTOFUSE 80 Piece Fuse Assortment

Contents:

(10) ATO 3    (10) ATO 10    (10) ATO 25  
 (10) ATO 5    (10) ATO 15    (10) ATO 30  
 (10) ATO 7.5    (10) ATO 20

## 48601

ATO/MINI 80 Piece Fuse Assortment

(w/ #48603 Fuse Puller)

Contents:

(10) ATO 15    (10) MIN 15  
 (10) ATO 20    (10) MIN 20  
 (10) ATO 25    (10) MIN 25  
 (10) ATO 30    (10) MIN 30  
 (1) 48603 Fuse Puller



## 48603 Fuse Puller

For easy fuse removal and replacement of Glass, ATO and MINI Fuses.

Box Qty. 1

# MINIATURE LAMPS

## MINIATURE LAMPS - USA MANUFACTURER

All Bulbs are packaged in boxes of 10,  
except for \*, which is packaged in a box of 2



Type 1



Type 2



Type 3



Type 4



Type 5



Type 6



Type 7



Type 8



Type 9



Type 10



Type 11



Type 12



Type 13



Type 14



Type 17

Prod No.	Bulb No.	Bulb Type	Prod No.	Bulb No.	Bulb Type
1995	24	10	2270	1893	5
1996	24NA	10	2275	1895	4
2010	53	4	2280	2057	1
2020	63	4	2285	2057NA	1
2025	67	4	2286	2357	1
2030	74	10	2287	2357NA	1
2035	89	4	2305	2721	5
2055	97	4	2288	3057	17
2085	194	2	2289	3057NA	17
2095	194NA	2	2303	3156	17
2100	211-2	6	2304	3156A	7
2105	212-2	6	2290	3157	17
2120	561	12	2291	3157NA	17
2135	631	4	2308	3157NALL	
2140	904	10		4157NALL	17
2145	906	10	2299	DE-3022	9
2150	912	10	2300	DE-3175	9
2146	916	10	2306	3357/3457	17
2147	916NA	10	2307	3357A/3457A	17
2335*	921	2	2340*	3496	1
2155	1003	3	2341	3496	1
2160	1004	1	2345	3497	5
2180	1141	3	2347	3757KA	7
2190	1154	1	2346*	4114LL	17
2200	1156	3	2348	4157LL	17
2201	1156NA	3	2315	6411	10
2205	1157	1	2310	6418	9
2215	1157NA	1	2320*	7225	2
2238	1295NA	3	2325*	7440	2
2250	1816	5	2330*	7443	2
2260	1891	5			

Electrical

# HEADLAMPS

## AERODYNAMIC HALOGEN HEADLAMPS USA MANUFACTURER

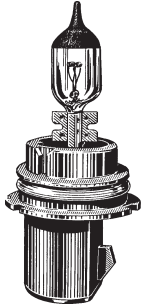

**2295**  
9004 BULB  
High-Low Beam  
In Single Headlight  
Assemblies  
Box Qty. 1

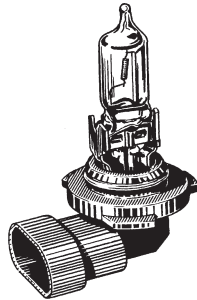

**2296**  
9005 BULB  
High Beam  
In Dual Headlight  
Assemblies  
Box Qty. 1

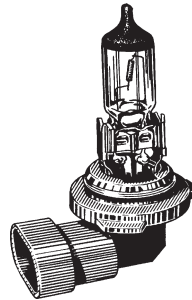

**2297**  
9006 BULB  
Low Beam  
In Dual Headlight  
Assemblies  
Box Qty. 1

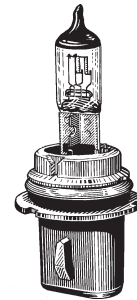

**2294**  
9007 BULB  
High-Low Beam  
In Single Headlight  
Assemblies  
Box Qty. 1

Electrical



**2350**  
12 Volt  
H1 Halogen Lamp  
Box Qty. 1



**2355**  
12 Volt  
H3 Halogen Lamp  
Used in Fog Lamps  
Box Qty. 1



**2360**  
H7  
Halogen Lamp  
Box Qty. 1

## AERODYNAMIC HALOGEN HEADLAMPS IMPORT



**2714**  
9004 BULB (Import)  
High-Low Beam  
In Single Headlight  
Assemblies  
Box Qty. 1

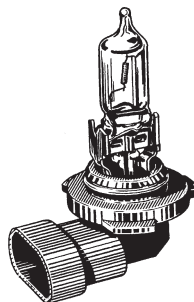

**2715**  
9005 BULB (Import)  
High Beam  
In Dual Headlight  
Assemblies  
Box Qty. 1

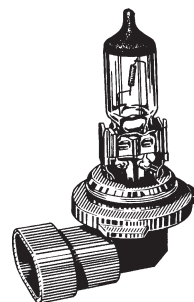

**2716**  
9006 BULB (Import)  
Low Beam  
In Dual Headlight  
Assemblies  
Box Qty. 1

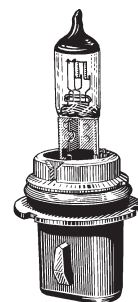

**2717**  
9007 BULB (Import)  
High-Low Beam  
In Single Headlight  
Assemblies  
Box Qty. 1

# IMPORT LAMPS

Prod No.	Bulb No.	Bulb Type
2604	24	2
2605	24NA	2
2600	67	4
2610	194	2
2620	194NA	2
2625	906	10
2626	916NA	10
2630	1156	3
2635	1156NA	3
2640	1157	1
2650	1157NA	1
2660	1895	4
2670	2057	1
2680	2057NA	1
2684	3057	17
2685	3057NA	17
2687	3156	17
2690	3157	7
2691	3157NA	7
2695	3357	7
2696	3357NA	7
2698	3496	5
2699	3497	5
2700	7440	10
2701	7440NA	10
2703	7443	10
2704	7443NA	10

10 Lamps Per Box



Type 1



Type 2



Type 3



Type 4



Type 5



Type 7



Type 10



Type 17

Electrical

# MISCELLANEOUS

## ROUGH SERVICE BULBS HEAVY DUTY

- \* Brass Base resists corrosion in socket
- \* Vibration resistant, reinforced element withstands unusual shock and abuse
- \* Long Life 5000 Hours
- \* 120/130 volt

Prod. No.	Watts	Qty.
2500	50	6
2510	75	6

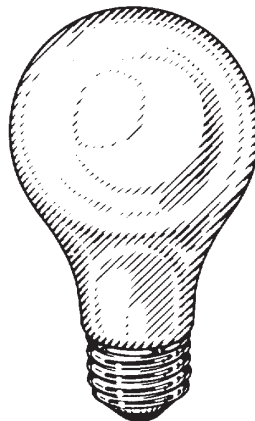

## SAFETY COATED ROUGH SERVICE BULBS

Same features as our Heavy Duty Rough Service Bulbs but are Rubber Coated to eliminate potential flying glass fragments due to accidental breakage. They also have thermal shock resistance to extreme temperature changes from water sprays, weld spatter or melting snows.

Prod. No.	Watts	Qty.
2520	50	6
2530	75	6

# MISCELLANEOUS

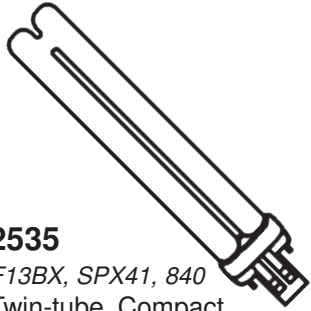

**2535**  
*F13BX, SPX41, 840*  
 Twin-tube, Compact  
 Rough service replacement  
 fluorescent light bulb  
 13 Watt, 110 Volts  
 GX23 Base (2 Pin)  
 Box Qty. 1

## ALKALINE BATTERIES



Prod. No.	Description	Bx Qty
<b>3507</b>	AAA ..... 1.5 Volt	4
<b>3505</b>	AA ..... 1.5 Volt	4
<b>3510</b>	9 Volt	1
<b>3515</b>	C ..... 1.5 Volt	2
<b>3520</b>	D ..... 1.5 Volt	2

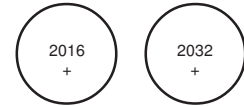

## 3 VOLT LITHIUM BATTERY

Used with various **Keyless Remote Entry Systems** and other various small electronic devices.

Prod. No.	Industry No.	Qty.
<b>3525</b>	2016	5
<b>3530</b>	2032	5

Electrical

## BATTERY CABLE

Marine Grade  
 Rated 600v, 221° F dry / 193° F wet  
 100 ft. Roll



- 1180** ..... 8 ga. Red
- 1181** ..... 8 ga. Black
- 1182** ..... 6 ga. Red
- 1183** ..... 6 ga. Black
- 1184** ..... 4 ga. Red
- 1185** ..... 4 ga. Black
- 1186** ..... 2 ga. Red
- 1187** ..... 2 ga. Black



## 400540

Copper Battery Terminal  
 Heavy Duty, Straight  
 For Negative Posts  
 2-1 Ga.  
 Die Code Settings: Pink H-H  
 1/Bx

## STANDARD WALL STARTER LUGS

Copper, Unplated



- 396701** ..... 4 Ga. .... 5/16" Hole ..... 25/bx
- 396702** ..... 4 Ga. .... 3/8" Hole ..... 25/bx
- 396705** ..... 2 Ga. .... 5/16" Hole ..... 25/bx
- 396706** ..... 2 Ga. .... 3/8" Hole ..... 25/bx
- 396707** ..... 2/0 Ga. .... 5/16" Hole ..... 25/bx
- 396708** ..... 2/0 Ga. .... 3/8" Hole ..... 25/bx

## 400541

Copper Battery Terminal  
 Heavy Duty, Straight  
 For Positive Posts  
 2-1 Ga.  
 Die Code Settings: Pink H-H  
 1/Bx

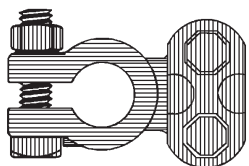

## 400520

Universal Top Mount  
 Battery Terminal  
 Heavy Duty  
 For Pos. & Neg. Posts  
*Cable Range:*  
 8 thru 2/0 AWG  
 Card of 10

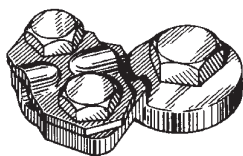

## 400530

Universal Side Mount  
 Battery Terminal  
 Heavy Duty  
 For Pos. & Neg. Posts  
*Cable Range:*  
 8 thru 2/0 AWG  
 Card of 8

## 400542

Wing Nut Battery Terminal  
 Brass Plated  
 For Positive Posts  
 Terminal Stud Size 3/8"  
 1/Bx



## 400543

Wing Nut Battery Terminal  
 Brass Plated  
 For Negative Posts  
 Terminal Stud Size 5/16"  
 1/Bx



## 400535

Zinc Plated  
 Battery Terminal Bolts  
 1/4-20 x 1-1/4  
 Square Head  
 Box Qty. 50

# GM SPECIALTY CONNECTORS

## GM 56 SERIES

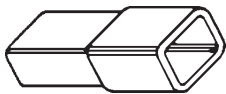

### 396681

2962984  
Insulates #396686, #396680  
Mates w/Shell #396682  
Box Qty. 25



### 396660

2965142  
Insulated w/Shell #396682  
Mates with #396680  
Tin Plated  
16-14 Gauge Wire  
Box Qty. 25



### 395590

2084421, 2962447  
Insulated w/Shell #396682  
Mates with #396686  
Unplated Brass  
16-14 Gauge Wire  
Box Qty. 50



### 396687

2962574  
Insulated w/Shell #396682  
Mates w/Terminal #396688  
Copper Alloy  
12 Gauge  
Box Qty. 25



### 396682

2962448  
Insulates #395590, #396660  
Mates w/Shell #396681  
Box Qty. 25



### 396680

2971962  
Insulated w/Shell #396681  
Mates w/Terminal #396660  
Tin Plated  
16-14 Gauge  
Box Qty. 25



### 396686

2962987  
Insulated w/Shell #396681  
Mates w/Terminal #395590  
Unplated Brass  
16-14 Gauge  
Box Qty. 25



### 396688

8917283  
Insulated w/Shell #396681  
Mates with #396687  
Tin Plated Copper  
12-10 Gauge Wire  
Box Qty. 25

## GM WEATHER PACK SERIES



### 395610

12033674, 12089040  
Mates with #395620  
Tin Plated  
20-18 Gauge  
Box Qty. 25



### 395620

12034051, 12089188  
Mates with #395610  
Tin Plated  
20-18 Gauge  
Box Qty. 25



### 396021

12010085, 12089305  
Mates with #396622  
Tin Plated  
16-14 Gauge  
Box Qty. 25



### 396622

12010182, 12124580  
Mates with #396021  
Tin Plated  
16-14 Gauge  
Box Qty. 25



### 396691

12014836  
Connector and Seal Set  
Set of 395610 & 395650  
20-18 Gauge  
Box Qty. 25 Sets

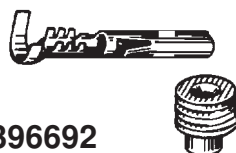

### 396692

12014837  
Connector and Seal Set  
Set of 395620 & 395650  
20-18 Gauge  
Box Qty. 25 Sets



### 395650

12015323  
Use with #'s 395610, 395620,  
396622, 396021  
Green Silicone  
Cable Seal  
Box Qty. 10



### 396690

12010300  
Silicone  
Cavity Plug  
Used to Plug Empty  
Cavities in Connector Shells  
Box Qty. 25

# GM SPECIALTY CONNECTORS

## GM MICRO-PACK TERMINALS



### 395623

12034053, 12004610

Tin Plated  
GM Electronic Control  
Module Terminal  
20-18 Gauge  
Box Qty. 10



### 395624

1202757

Tin Plated  
Electronic Control Module  
Terminals Short  
20-18 Gauge  
Box Qty. 10



### 395112

12040902

Tin Plated  
22 Gauge  
Box Qty. 25

## GM PACK-CON I SERIES TERMINALS



### 395637

8900524, 12020320

Mates with #395113

Tin Plated  
16-14 Gauge  
Box Qty. 25



### 395113

12020347

Mates with #395637

16-14 Gauge  
Box Qty. 25



### 395114

6294511

Mates with #395636

Tin Plated  
20-18 Gauge  
Box Qty. 25



### 395636

12020346, 6294512

Mates with #395114

20-18 Gauge  
Box Qty. 25

Electrical

## GM PACK-CON H.D. I SERIES TERMINALS



### 395115

12033817

Tin Plated  
12-10 Gauge  
Box Qty. 10



### 395116

8905087

Tin Plated  
16-14 Gauge  
Box Qty. 10

## GM PACK-CON II SERIES TERMINALS



### 395117

12004996

Tin Plated  
16-14 Gauge  
Box Qty. 10

## GM METRI-PACK 150.1 SERIES TERMINAL



### 396693

12052922, 12089340

Not for use w/150.2 Series  
20-18 Gauge  
Box Qty. 25

## GM METRI-PACK 150 SERIES TERMINALS



### 395118

12047680

Mates with #395119

Tin-Plated  
20-18 Gauge  
Box Qty. 10



### 395119

12047581

Mates with #395118

Tin-Plated  
20-18 Gauge  
Box Qty. 25



### 395659

12052466

Tin Plated  
24 Gauge  
Box Qty. 10



### 396000

12047767, 4368618

Tin Plated  
20-16 Gauge  
Box Qty. 25

# GM SPECIALTY CONNECTORS

## GM METRI-PACK 280 SERIES TERMINALS



**395621**  
12020116  
Mates with #395622  
Tin Plated  
18-14 Gauge  
Box Qty. 10



**395622**  
12015857  
Mates with #395621  
Tin Plated  
18-14 Gauge  
Box Qty. 10



**396002**  
12034047  
Mates with #396003  
Tin Plated  
20-18 Gauge  
Box Qty. 25



**396003**  
12034046  
Mates with #396002  
Tin Plated  
20-18 Gauge  
Box Qty. 25

## GM METRI-PACK 480 SERIES TERMINALS



**396004**  
12020120  
Mates with #396005  
Tin Plated  
3/16" Blade Width  
16-14 Gauge Wire  
Box Qty. 10



**396005**  
12015861  
Mates with #396004  
Tin Plated  
16-14 Gauge Wire  
Box Qty. 25

## GM METRI-PACK 630 SERIES TERMINALS



**396006**  
12020126  
Mates with #396007  
Tin Plated  
1/4" Blade Width  
16-14 Gauge Wire  
Box Qty. 25



**396007**  
12015870  
Mates with #396006  
Tin Plated  
16-14 Gauge Wire  
Box Qty. 25

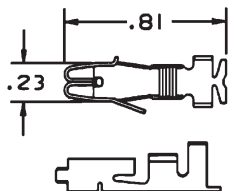

**395560**  
6294738  
Terminal for Two 18 or 20  
Gauge Wires  
Box Qty. 25



**396020**  
2965580, 2096467,  
C1SF-14474-A  
Unplated  
Female Terminal 1/4" Tab  
14-12 Gauge  
Box Qty. 25

## GM & FORD POWER WINDOW DOOR LOCK TERMINALS



**396009**  
E25B-14488AC,  
E8EB-14488-AGA  
12 Gauge  
Box Qty. 10

Electrical

Visit us at

**[www.srfast.com](http://www.srfast.com)**

for the most up to date catalog pages

# FORD SPECIALTY CONNECTORS

## FORD WEDGELOCK PIN TYPE TERMINALS



**395627**

D1AB-14461-AA  
Mates With #395628  
.110" Dia. Pin  
20-18 Gauge  
Box Qty. 10



**395628**

D1AB-14488-CA  
Mates With #395627  
.110" Dia. Pin  
20-18 Gauge  
Box Qty. 10



## FORD TERMINALS



**395631**

D20B-14421-BB  
3/16" Blade Width  
20-18 Gauge  
Box Qty. 25



**395632**

D5AB-14474-FA,  
D3AZ-14474-G  
20-18 Gauge  
Box Qty. 25

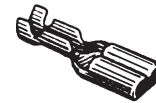

**395633**

C5AB-14474-B, 2096466  
1/4" Tab  
20-18 Gauge  
Box Qty. 25

## FORD MINI-BLOCK TERMINALS



**396017**

E8EB-14421-LA  
Mates with #396016  
1/8" Blade Width  
16-14 Gauge  
Box Qty. 10



**396018**

E7EB-14421-EA  
Mates with #396019  
1/8" Blade Width  
20-18 Gauge  
Box Qty. 10



**395629**

D8BB-14474-BA,  
D3AB-14474-DA  
20-18 Gauge  
Box Qty. 25



**396011**

D20B-14421-CB  
3/16" Blade Width  
16-14 Gauge  
Box Qty. 10



**396016**

E8EB-14474-AJA  
Mates with #396017  
For 1/8" Blade  
16-14 Gauge  
Box Qty. 10



**396019**

E7EB-14474-CA  
Mates with #396018  
For 1/8" Blade  
20-18 Gauge  
Box Qty. 10



**396015**

E8EB-14474-AKA  
For 1/8" Blade  
12-10 Gauge  
Box Qty. 10



## FORD MICRO FEMALE TERMINAL

**396694**

E8EB-14474-AMA  
Fits 1/8" Wide Tab  
16-14 Gauge  
Box Qty. 25

# FORD SPECIALTY CONNECTORS



## 395638

Terminal, Female  
Mates w/Pin Style  
Male Terminal  
Fuel Tank Sending Unit  
16-14 Gauge  
Ford and General Purpose  
Box Qty. 25



## 395639

Terminal, Female  
Mates w/Pin Style  
Male Terminal  
Fuel Tank Sending Unit  
20-18 Gauge  
Ford & General Purpose  
Box Qty. 25



## 396020

2965580, 2096467,  
C1SF-14474-A  
Unplated  
Female Terminal 1/4" Tab  
14-12 Gauge  
Box Qty. 25



## 396700

101028  
E7EB-14487-6A  
Mini Female Pin Receptacle  
16 Ga., 4" SXL Lead  
Ford Products  
Box Qty. 10

# CHRYSLER SPECIALTY CONNECTORS



## 396695

7368261  
Mates with #396696  
Male Pin Type Terminal  
3/32" Dia. Pin  
20-18 Gauge  
Box Qty. 25

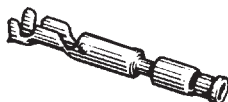

## 396696

4368163  
Mates with #396695  
Female Pin Type Terminal  
Fits a 3/32" Pin  
20-18 Gauge  
Box Qty. 25

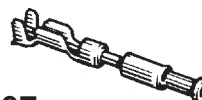

## 396697

4368960  
Female Pin Terminal  
Fits 60 Pin Connection  
Block on Fire Wall  
1/16" Dia. Pin  
20-18 Gauge  
Box Qty. 25



## 396698

4304729  
Double Cantilever  
Spring Terminal  
used on PC Board  
Connections and General  
Purpose  
24-18 Gauge  
Box Qty. 25

## CHRYSLER QUICK CONNECT ELECTRICAL TERMINALS



## 395634

3843386  
Mates With #395635  
1/4" Blade Width  
20-18 Gauge  
Box Qty. 25



## 395635

3843601  
Mates With #395634  
Tin Plated Brass  
For 1/4" Blade  
20-18 Gauge  
Box Qty. 25



## 396013

3843386  
Mates with #396014  
1/4" Blade Width  
16-14 Gauge  
Box Qty. 10



## 396014

3843601  
Mates with #396013  
1/4" Blade Width  
16-14 Gauge  
Box Qty. 10

# UNIVERSAL



## 396020

2965580, 2096467,  
C1SF-14474-A  
Unplated  
Female Terminal 1/4" Tab  
14-12 Gauge  
Box Qty. 25



## 395633

C5AB-14474-B, 2096466,  
2965470  
Brass  
Female Terminal 1/4" Tab  
20-18 Gauge  
Box Qty. 25



# GM PIGTAIL SOCKET ASSEMBLIES

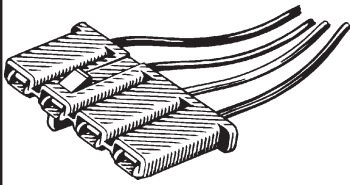

**400090**  
*Not Supplied by OEM*  
 Voltage Regulator Pigtail  
 4-Leads  
 GM Cars  
 Box Qty. 12

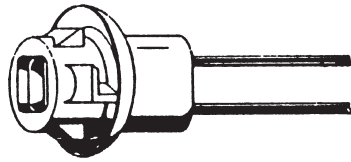

**400100**  
 Repair Harness -  
 Marker Light  
 12" Leads  
*Use with Bulb's #194, 194A*  
 GM & Ford Cars '68-UP  
 Box Qty. 1

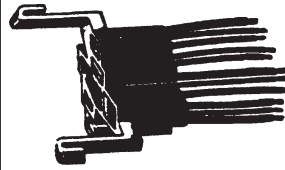

**400110**  
 Repair Harness -  
 Ignition  
 10 Leads, 6" Length  
 Chevrolet "C", "G"  
 & "P" Trucks  
 '67 - '93  
 Box Qty. 1



**400130**  
 2962510  
 Repair Harness -  
 Air-Conditioner  
 Blower Relay  
 18 Ga. Wire  
 GM, AMC & Chrysler  
 Box Qty. 10

Electrical

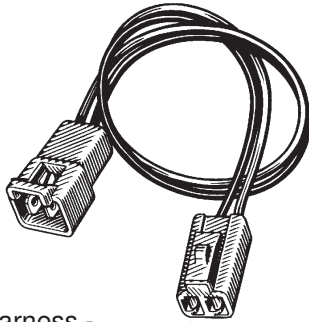

**400360**  
 Repair Harness -  
 Alternator Leads Extender  
 GM Cars and Trucks  
 Box Qty. 12

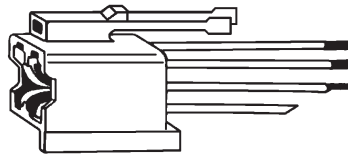

**400400**  
 "Blue"  
 Repair Harness-Radio Rear Speaker  
 GM '78 - UP  
 Box Qty. 6

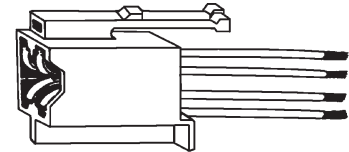

**400420**  
 "White"  
 Repair Harness-Radio Front Speaker  
 GM '78 - UP  
 Box Qty. 6

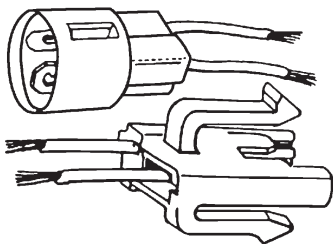

**400460**  
 Repair Harness -  
 Power Window Regulator Motor  
 GM Products  
 Box Qty. 1

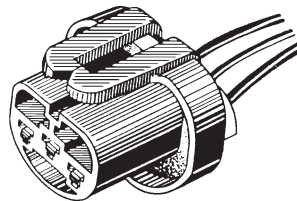

**400481**  
 Repair Harness - Headlamp Socket  
*For #9004 & #9007 Halogen Bulb*  
 3 Prong, GM Style  
 3 - 10" leads, 18 Ga. wire  
 GM, Ford, Chrysler  
 Box Qty. 5

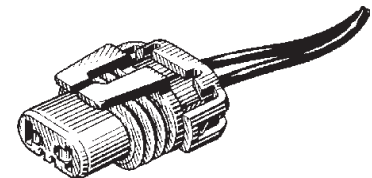

**400482**  
 12101898, PT168  
 Repair Harness - Headlamp Socket  
*For #9005 Halogen Bulb (High Beam)*  
 2 Prong, Two Indexing Grooves  
 2 - 10" Leads, 18 Ga. Wire  
 GM '86 - UP, Ford, Chrysler  
 Box Qty. 5

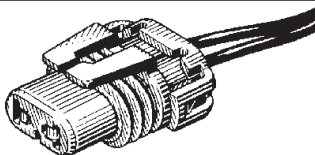

**400483**  
 12101897, PT167  
 Repair Harness - Headlamp Socket  
*For #9006 Halogen Bulb (Low Beam)*  
 2 Prong, One Indexing Groove  
 2 - 10" Leads, 16 Ga. Wire  
 GM '86 - UP, Ford, Chrysler  
*Also #899 Fog Lamp Bulb*  
 Ford Explorer '97 - UP  
 Box Qty. 5

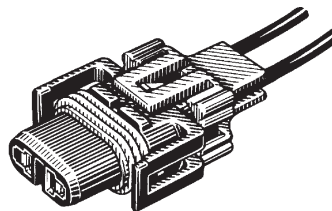

**400484**  
 12043215  
 Repair Harness -  
 Socket Assembly Halogen Bulb  
*For Cornering and Fog Lamp*  
 Bulb #'s 886, 881, 889  
 2 - 18 Ga. 7" Leads  
 GM Fog '83 - UP, Cornering '87 - UP  
 Box Qty. 1

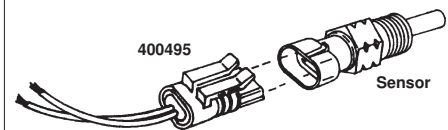

**400495**  
 12046623, 12101899, PT169  
 Repair Harness -  
 Coolant Temp. Sensor  
 Crank Sensor #'s 1103703, 1103661  
 & 10456043  
 2-18 Ga. 12" Leads  
 GM '85 - UP  
 Box Qty. 1

# GM PIGTAIL SOCKET ASSEMBLIES

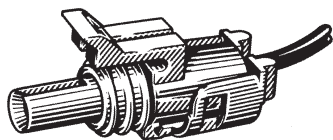

## 400505

12117385, PT517  
 Repair Harness -  
 Exhaust Oxygen Sensor (O<sup>2</sup>)  
 (For Single Wire Harness)  
 1-18 Ga. GXL 8" Lead  
 GM '82 - UP, AMC, Jeep, Isuzu  
 Box Qty. 1



## 400506

Repair Harness -  
 Idle Air Control Valve  
 4-18 Ga. 10" Leads w/Seal  
 GM '82 - UP w/Fuel Injection  
 Box Qty. 1

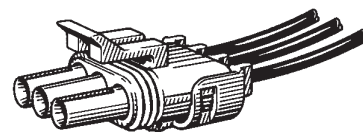

## 400507

12116257, PT430  
 Repair Harness -  
 Throttle Position Sensor  
 3-18 Ga. 10" Leads w/Seal  
 GM '83 - UP w/Fuel Injection  
 Box Qty. 1

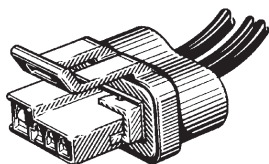

## 400508

12085525, 26, 27, 28, 12101895,  
 1217361, PT494  
 Repair Harness -  
 Voltage Regulator Module  
 Reg. #'s 1116411, 1116408  
 2-18 Ga., 1-12 Ga. 3" Leads  
 GM '86 - UP w/Internal Regulators  
 Box Qty. 1



## 400509

Repair Harness - Distributor Module  
 2-18 Ga. GXL 8" Leads  
 GM '85 - UP w/6 Cyl. Engines  
 Also Chrysler Horns '91 - '95  
 Box Qty. 1

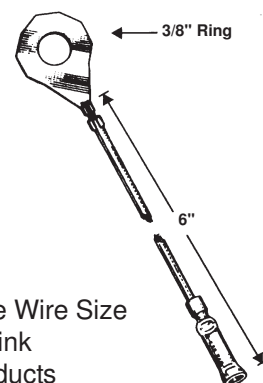

## 400510

8915135  
 14 Gauge Wire Size  
 Fusible Link  
 G.M. Products  
 Box Qty. 10

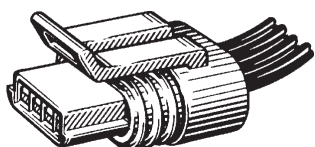

## 400511

Repair Harness - Distributor Module  
 Module # 1987466; Crank Sensor #'s  
 25526124, 25535481, 25526122  
 4-18 Ga. GXL 8" Leads  
 GM w/2.8 Eng. '85 - UP  
 GM w/3.8 Eng. '88 - UP  
 Also IAC Valves:  
 GM '87 - '95, Chrysler '86 - '95  
 Box Qty. 1

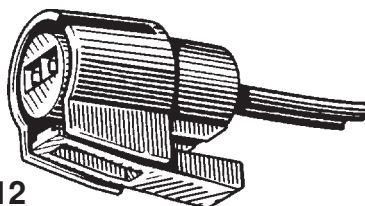

## 400512

12085521, PT131  
 Repair Harness - A/C Compressor  
 High Pressure Switch  
 2-18 Ga. 7" Leads  
 (Index Slot at 1 o'clock)  
 GM all w/ V-5 Compressor  
 Box Qty. 1

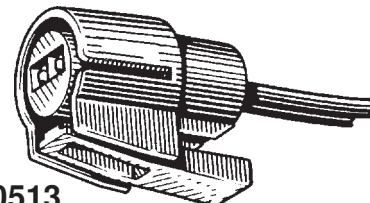

## 400513

12085503, PT124  
 Repair Harness - A/C Compressor  
 Low Pressure Switch  
 2-18 Ga. 7" Leads  
 (Index Slot at 3 o'clock)  
 GM all w/ V-5 Compressor  
 Box Qty. 1

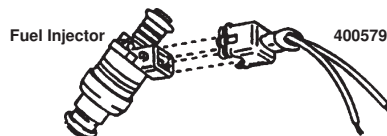

## 400579

12085491  
 Repair Harness -  
 Fuel Injector Plug  
 2 - 18 Ga. SXL 8" Leads  
 Lucas & Bosch Injectors  
 w/ External Spring Clip Retainer  
 Domestic & Import Vehicles  
 Box Qty. 1

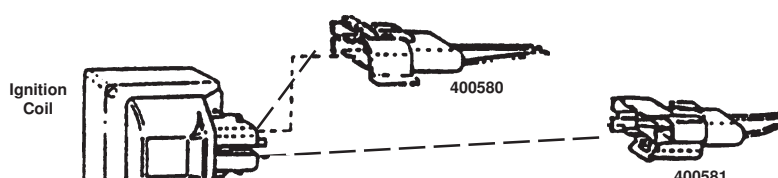

## 400580

Fits Coils: 1115315, 1115317  
 Repair Harness - Ignition Coil  
 Gray Plug  
 1-18 Ga., 1-12 Ga. GXL 8" Lead  
 GM '85 - UP  
 Box Qty. 1

## 400581

Fits Coils: 1115315, 1115317  
 Repair Harness - Ignition Coil  
 Black Plug  
 2-18 Ga. GXL 8" Leads  
 GM '85 - UP  
 Box Qty. 1

Electrical

# GM PIGTAIL SOCKET ASSEMBLIES

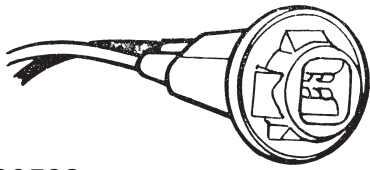

## 400582

6294015, 8901283, 8918527,  
D40Z-13410E, D7AZ-13412A,  
D7FZ-13412A  
Side Marker & License Plate Lights  
Bulb #'s 158, 194, 194A  
GM, Ford  
Box Qty. 1

Idle Speed  
Control Assy.

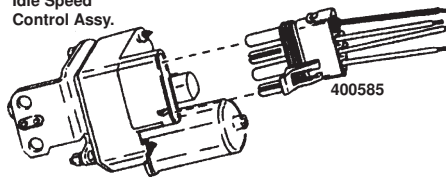

## 400585

Fits Assy. #'s 17079129, 17079121  
Repair Harness - Idle Speed Control  
4-18 Ga. GXL 8" Leads  
GM Products '81 - '87  
V6 & V8 Engines, w/Carburetors  
Box Qty. 1

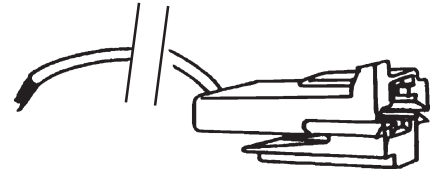

## 400610

Repair Harness -  
Carburetor Choke Heater  
1-18 Ga. 7" Lead  
GM Products w/Carburetors  
'82 - UP  
Box Qty. 5

Electrical

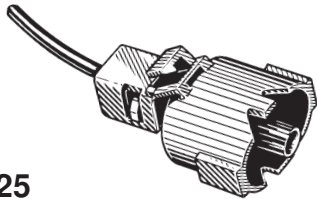

## 400625

12051234, 12102621, PT308  
Repair Harness - A/C Compressor  
Coolant, cooling Fan Temp Switch &  
Knock Sensor  
10" Lead  
GM Products '82 - UP  
Box Qty. 1

Fuel Injector

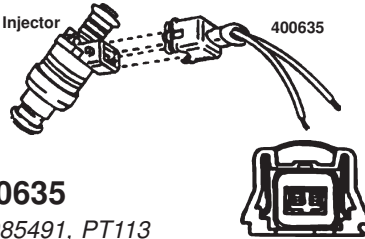

## 400635

12085491, PT113  
Repair Harness - Fuel Injector  
2 - 18 Ga. GXL 8" Leads  
Lucas & Bosch Injectors  
w/ External Spring Clip Retainer  
Domestic & Import Vehicles  
Box Qty. 1

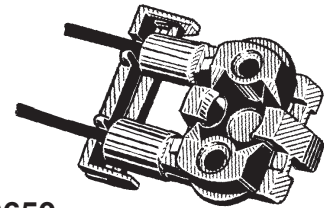

## 400650

12029960, 12102568, PT285  
Repair Harness -  
Throttle Body Fuel Injectors  
2-18 Ga. GPT 8" Leads  
GM '82 - UP  
Box Qty. 1

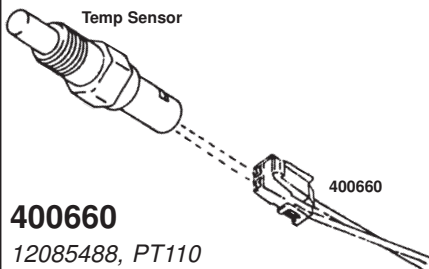

## 400660

12085488, PT110  
Repair Harness -  
Coolant Temper Sensor (#25036628)  
2-18 Ga. GXL 8" Leads  
GM '84 - UP  
Box Qty. 1

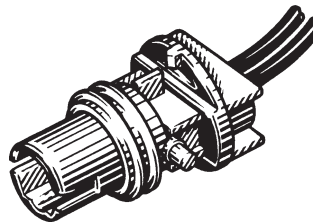

## 400665

12083007, LS13  
Repair Harness - Side Marker Lamp  
Accepts #24 Bulb  
2-18 Ga. 12" Leads  
GM '88 - UP  
Box Qty. 1



## 400671

12101907, PT179  
Repair Harness - A/C Compressor  
2-18 Ga. GXL Leads w/Diode &  
1 Molded Pin Grip 90° Term. End  
GM '83 - '89  
Box Qty. 1

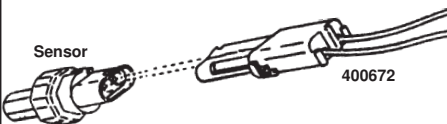

## 400672

12085524, PT134  
Repair Harness - Manifold Absolute  
Temperature (M.A.T.) Sensor  
2-16 Ga. GXL 8" Leads  
GM Vehicles '90 - UP  
Box Qty. 1

Fan Relay



## 400673

Not Supplied By O.E.  
Repair Harness - Cooling Fan Relay  
Fits Relay #10038311  
5-18 Ga. GPT 8" Leads  
GM '85 - 88  
Box Qty. 1

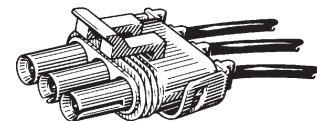

## 400679

12085507  
Repair Harness - A/C Pressure  
Switch Fits #25527510 3-18  
Gauge (GXL) 8" Leads  
GM Vehicles '84 - 89  
Box Qty. 1

# GM PIGTAIL SOCKET ASSEMBLIES

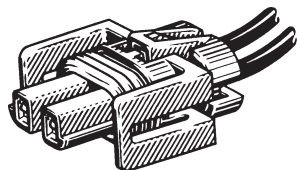

## 400684

Rep: 12102696, PT363  
 Repair Harness -  
 Various Accessory Relays  
 5-16 GA GXL 8" Leads  
 General Purpose  
 Ford, Chrysler,  
 GM '80 - UP  
 Box Qty. 1

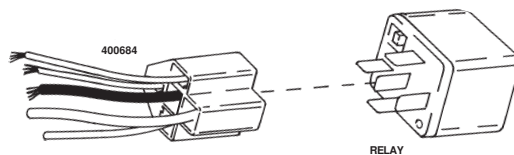

## 400680

12101937  
 Repair Harness -  
 A/C Compressor Clutch  
 2-18 Ga. 8" GPT Leads  
 GM '89 - UP  
 Box Qty. 1

## 400711

Repair Harness -  
 Fan Speed Switch  
 Switch #'s 16015256,  
 16032480  
 4 Leads: 1-14 Ga.;  
 2-16 Ga.; 1-18 Ga.  
 8" GPT Wire Leads  
 GM '77 - UP  
 Box Qty. 1

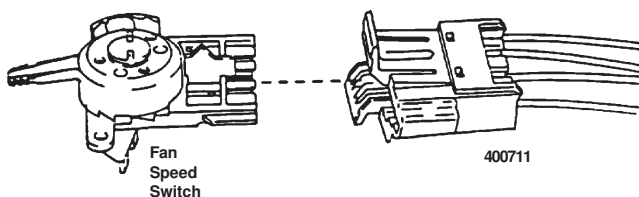

Electrical

# CHRYSLER PIGTAIL SOCKET ASSEMBLIES

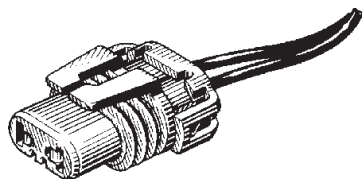

## 400482

12101898, PT168  
 Repair Harness - Headlamp Socket  
 For #9005 Halogen Bulb (High Beam)  
 2 Prong, Two Indexing Grooves  
 2 - 10" Leads, 18 Ga. Wire  
 GM '86 - UP, Ford, Chrysler  
 Box Qty. 5

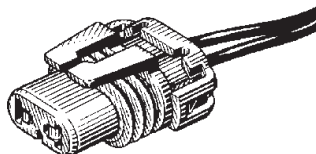

## 400483

12101897, PT167  
 Repair Harness - Headlamp Socket  
 For #9006 Halogen Bulb (Low Beam)  
 2 Prong, One Indexing Groove  
 2 - 10" Leads, 16 Ga. Wire  
 GM '86 - UP, Ford, Chrysler  
 Also #899 Fog Lamp Bulb  
 Ford Explorer '97 - UP  
 Box Qty. 5

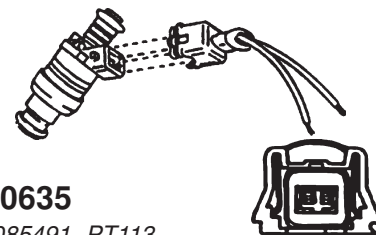

## 400635

12085491, PT113  
 Repair Harness - Fuel Injector  
 2 - 18 Ga. GXL 8" Leads  
 Lucas & Bosch Injectors  
 w/ External Spring Clip Retainer  
 Domestic & Import Vehicles  
 Box Qty. 1

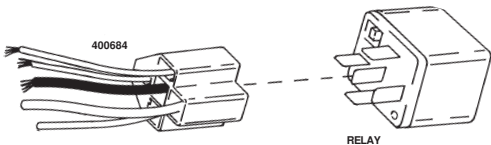

## 400684

Rep: 12102696, PT363  
 Repair Harness -  
 Various Accessory Relays  
 5-16 GA GXL 8" Leads  
 General Purpose  
 Ford, Chrysler,  
 GM '80 - UP  
 Box Qty. 1



## 400705

Use with #400635  
 Rubber Boot (Neoprene)  
 Fuel Injector Connector,  
 Protects Against Moisture  
 Domestic & Import Vehicles  
 Box Qty. 10

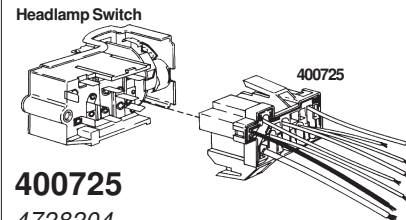

## 400725

4728204  
 Repair Harness - Headlamp Switch  
 Switch # 56007043  
 9 Leads: 1 - 12 Ga., 2 - 14 Ga.,  
 6 - 18 Ga.  
 Dodge Dakota, "B" Van &  
 Full Size Pickup '90 - UP  
 Box Qty. 1

# FORD PIGTAIL SOCKET ASSEMBLIES

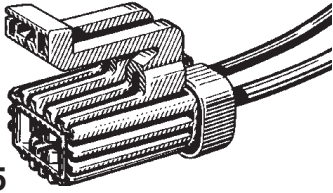

## 400165

Repair Harness -  
Heater Blower Motor  
2 - 12" Leads  
Ford Trucks '82 - '86  
Radiator Cooling Fan Motor  
Ford 4 Cyl. Engines '79 - UP  
Box Qty. 3



## 400315

Repair Harness -  
Vehicle Speed Sensor  
(Base #9E731)  
A.B.S. Wheel Speed Sensor  
(Base #2L373)  
2-18 ga. GXL 8" Leads  
Ford Various Models '93 - UP  
Box Qty. 1

Electrical

## 400317

F2AZ-14489-W  
Repair Harness Kit -  
Ignition Switches  
Switch #F2DZ-11572-A &  
F4DZ-11572-B  
3 - 10 ga. GPT 4" Leads  
3 - 12 ga. GPT 4" Leads  
1 - 20 ga. TWP 4" Lead  
Ford, Lincoln, Mercury,  
Lt. Duty Trucks '90 - UP  
Box Qty. 1

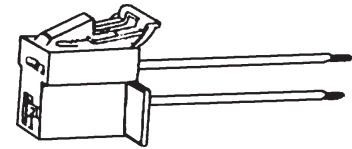
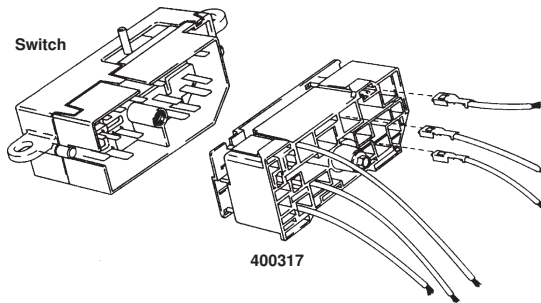

## 400320

Not Supplied By OEM  
Repair Harness - 100 Amp Alternator  
2 - 16 ga., 5 1/2" Leads  
Ford Products '75 - UP  
Box Qty. 10

## 400322

Repair Harness -  
Blower Motor Switch  
Switch #F5RZ-18578-A, F7RZ-18578-DA  
2 - 10 ga. GXL 8" Leads  
2 - 12 ga. GXL 8" Leads  
Ford Contour & Merc. Mystique  
'95 - UP  
Box Qty. 1

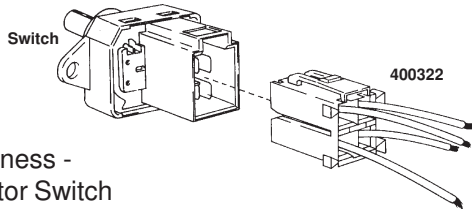

## 400325

Repair Harness -  
Radiator Cooling Fan Motor  
Fan & Shroud Assy. #F4DZ-8C607B, F5CZ-8C607-A  
2 - 12 ga. GXL 8" Leads  
1 - 10 ga. GXL 8" Lead  
Ford Taurus, Sable, Cont. Escort '90 - '96  
Contour, Mystique w/1 Motor 2.0 '95 - '97  
Box Qty. 1

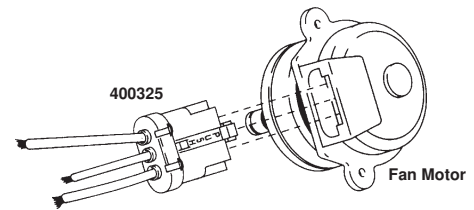

## 400327

Repair Harness Kit -  
Blower Motor Resistor  
Resistor #'s F1CZ-19A706-A & F7CZ-19A706-AA  
Kit Contains: 2 Repair Harnesses, 1 With 1 ea. of  
20, 16, 14 & 12 ga. GXL 8" Leads &  
1 With 1, 12 ga. GXL 8" Lead  
Ford Escort & Merc. Tracer '91 - UP  
Box Qty. 1 (1 of Each)

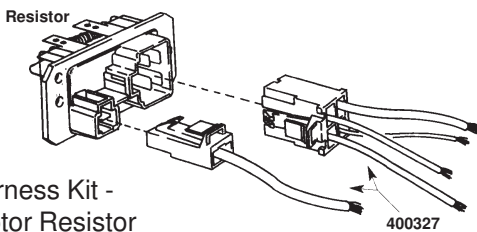

## 400330

Not Supplied By OEM  
Repair Harness - Voltage Regulator  
Ford Products '75 - UP  
Box Qty. 5

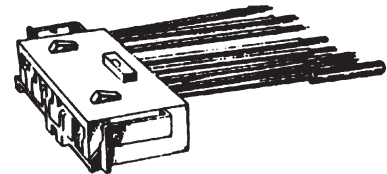

# FORD PIGTAIL SOCKET ASSEMBLIES

Electrical

## 400332

Repair Harness -  
Mass Air Flow Sensor  
*Sensors With Base #12B579*  
1 - 16 ga., 3 - 18 ga.  
GXL 8" Leads  
*Also: Fits Coil F0TZ-12029-A,  
F1SZ-12029-A*  
Ford Vehicles '89 - '92  
Box Qty. 1



## 400337

Harness Connector  
Master Cylinder, Door Jamb Switch,  
& Power Mirror  
Ford '87 - UP  
Box Qty. 1

## 400340

Repair Harness - Alternator  
3 - 10" Color coded Leads:  
2 - 10 Ga., 1 - 20 Ga.  
Ford Products  
6 Cyl. Engine w/75 Amp '89 - UP  
4 Cyl. Engine '85 - UP  
Box Qty. 1

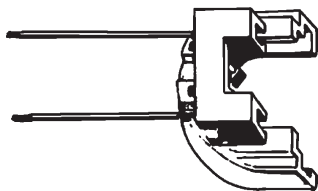
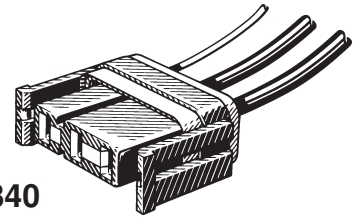

## 400380

*Not Supplied By OEM*  
Repair Harness - Coil To Ignition  
2 - 18 Ga., 8" Leads  
Ford Products '77 - UP  
Box Qty. 10



## 400455

Repair Harness -  
Air Conditioner Clutch Field Coil  
Socket w/12" Leads  
Ford Products  
Box Qty. 10



## 400456

Repair Harness - Heater & A/C  
Blower Switch  
*Fits Most Base #19986 Switches*  
5 - 12 Ga., 5" Leads w/Butt Conn.  
Most Ford Products '73 - UP  
Box Qty. 1

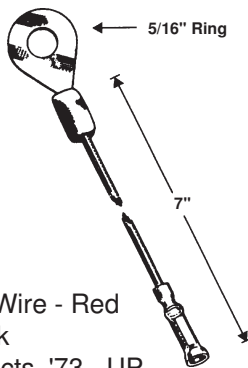

## 400470

18 Gauge Wire - Red  
Fusible Link  
Ford Products '73 - UP  
Box Qty. 10

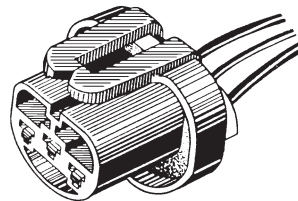

## 400481

Repair Harness - Headlamp Socket  
*For #9004 & #9007 Halogen Bulb*  
3 Prong, GM Style  
3 - 10" leads, 18 Ga. wire  
GM, Ford, Chrysler  
Box Qty. 5

## 400482

*12101898, PT168*  
Repair Harness - Headlamp Socket  
*For #9005 Halogen Bulb (High Beam)*  
2 Prong, Two Indexing Grooves  
2 - 10" Leads, 18 Ga. Wire  
GM '86 - UP, Ford, Chrysler  
Box Qty. 5

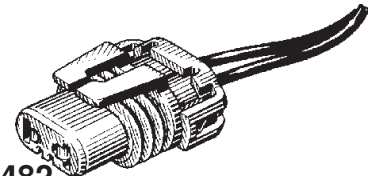

## 400483

*12101897, PT167*  
Repair Harness - Headlamp Socket  
*For #9006 Halogen Bulb (Low Beam)*  
2 Prong, One Indexing Groove  
2 - 10" Leads, 16 Ga. Wire  
GM '86 - UP, Ford, Chrysler  
*Also #899 Fog Lamp Bulb*  
Ford Explorer '97 - UP  
Box Qty. 5

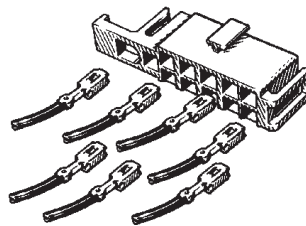
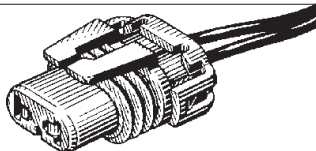

## 400516

Repair Harness Kit - Ignition Switch  
*Fits Switch #E6FZ-11572-A, SW1774B*  
Contains: 1 Socket, 4 - 12 Ga.,  
3 - 10 Ga. 4" GPT Leads  
Ford Products '80 - UP  
Box Qty. 1

## 400550

Repair Harness -  
Air Charge Temp. Sensor  
2 - 18 Ga. GXL 8" Leads  
Ford Product w/Fuel Injection  
'81 - UP  
Box Qty. 1

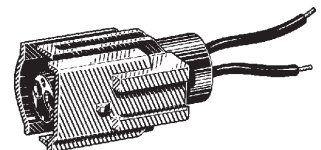

# FORD PIGTAIL SOCKET ASSEMBLIES

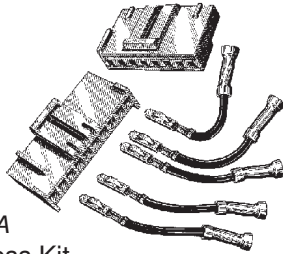

**400560**  
*E4FZ-8C290-A*  
 Repair Harness Kit -  
 Engine Cooling Fan Module  
 1 - 8 Pos. & 1 - 10 Pos. Connector  
 5 - 12 Ga., 4" Leads  
 Ford 4 & 6 Cyl. '83 - UP  
 Box Qty. 1

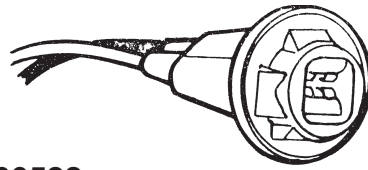

**400582**  
*6294015, 8901283, 8918527,*  
*D40Z-13410E, D7AZ-13412A,*  
*D7FZ-13412A*  
 Side Marker & License Plate Lights  
*Bulb #'s 158, 194, 194A*  
 GM, Ford  
 Box Qty. 1

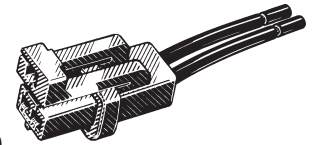

**400590**  
 Repair Harness -  
 Engine Fan Switch  
*Fits Switch #'s E5SZ-*  
*8B607-A, E4FZ-8B607-A*  
 2 - 14 Ga., 7" Leads  
 Black Connector  
 Ford Products '85 - UP  
 Box Qty. 1

Electrical

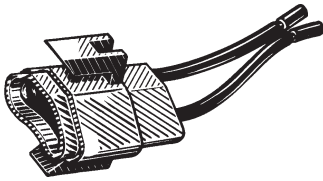

**400595**  
 Repair Harness -  
 Windshield Washer  
 Pump Assy.  
*Pump #'s E3AZ-17664-A,*  
*E0AZ-17664-A*  
 Ford Products '68 - UP  
 Box Qty. 1

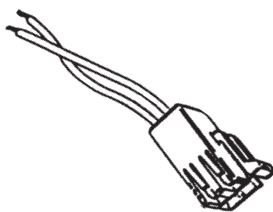

**400600**  
 Repair Harness -  
 Radio Speaker  
 2 - 18 Ga. 8" GPT Leads  
 Ford Products '80 - '89  
 Box Qty. 5

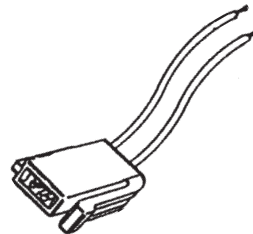

**400601**  
 Repair Harness -  
 Radio Speaker  
 3 - 18 Ga. 8" GPT Leads  
 Ford Products '89 - UP  
 Box Qty. 5

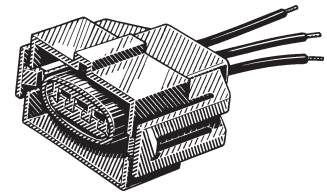

**400605**  
 Repair Harness - EGR Sensor  
*Sensor #E6AZ-9J460-A*  
 3 - 18 Ga. GLX 10" Leads  
 Ford Products '88 - UP  
 Box Qty. 1

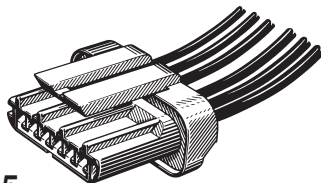

**400615**  
*E5ZZ-12A209-A*  
 Repair Harness -  
 Electronic Module EEC IV IGN.  
 6 - 14 Ga. GXL 8" Leads  
 Gray  
 Ford '83 - UP  
 Box Qty. 1

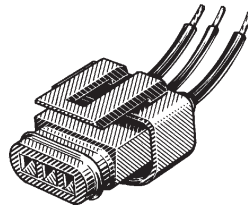

**400620**  
 Repair Harness -  
 Regulators & Coolant Level Sensors  
*Sensor Base #10D968*  
 3 - 16 Ga. Lead  
 Ford  
 Box Qty. 1

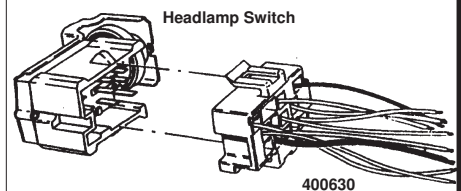

**400630**  
 Repair Harness - Headlamp Switch  
*Fits most switches with Base #11654*  
 9 - 8" Leads: 3 - 20 Ga., 4 - 8 Ga.,  
 1 - 16 Ga. & 1 - 12 Ga.  
 Ford Cars & Trucks '84 - UP  
 Box Qty. 1

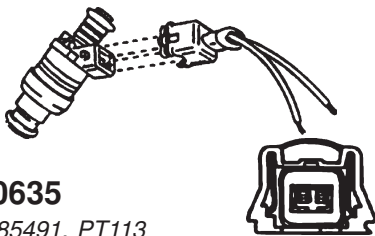

**400635**  
*12085491, PT113*  
 Repair Harness - Fuel Injector  
 2 - 18 Ga. GXL 8" Leads  
 Lucas & Bosch Injectors  
 w/ External Spring Clip Retainer  
 Domestic & Import Vehicles  
 Box Qty. 1

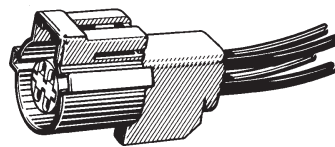

**400640**  
 Repair Harness -  
 Exhaust Oxygen Sensor  
*Sensor #'s F0TZ-9F472-A & C,*  
*F09Z-A & C, F1SZ-A, F1UZ-C, F9UZ-B*  
 3 - 18 Ga., & 1 - 16 Ga.  
 (GXL) 8" Leads, Gray Connector  
 Ford '89 - UP  
 Box Qty. 1

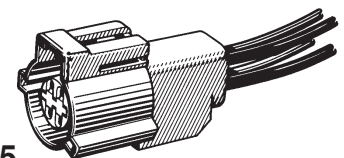

**400645**  
 Repair Harness -  
 Exhaust Oxygen Sensor  
*Sensor #'s F0TZ-9F472-B, F02Z-C,*  
*F03Z-A, F0SZ-A & B, F0TZ-E*  
 3 - 18 Ga., & 1 - 16 Ga.  
 (GXL) 8" Leads, Black Connector  
 Ford '89 - UP  
 Box Qty. 1

# FORD PIGTAIL SOCKET ASSEMBLIES

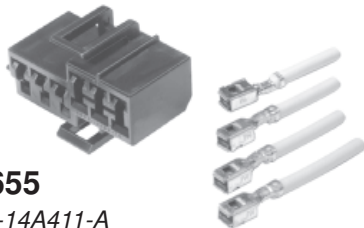

## 400655

E6DZ-14A411-A  
 Repair Harness - Ignition Switch  
 Switch # E7DZ-11572-A, SW1991  
 Contains: 1 Socket, 4 - 10 Ga. GPT  
 Terminated Leads  
 Ford Taurus & Sable '86 - UP  
 Box Qty. 1

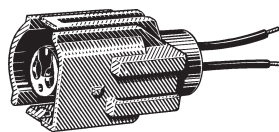

## 400670

Repair Harness -  
 Coolant Temp Sensor  
 Fits Sensor #E1AZ-12A648-A,  
 F2AZ-12A648-A  
 2 - 18 Ga. GXL 8" Leads  
 Ford vehicles '81 - UP  
 Box Qty. 1



## 400674

Repair Harness - Turn Signal Switch  
 Switch #'s E7FZ-13341-A, F33Z-13341-B  
 5 - 18 Ga. GPT 8" Leads  
 Ford '85 - UP  
 Box Qty. 1

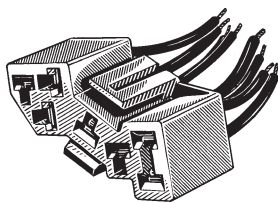

## 400675

Repair Harness - Turn Signal Switch  
 Switch #'s E7FZ-13341-A, F33Z-13344-B  
 2 - 18 Ga. & 6 - 16 Ga. GPT 8" Leads  
 Ford '85 - UP  
 Box Qty. 1

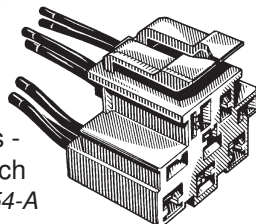

## 400676

Repair Harness -  
 Headlamp Switch  
 Fits #E6DZ-11654-A  
 & F2DZ-A  
 (Motorcraft SW-1976)  
 6 - 18 Ga., 1 - 16 Ga., 1 - 12 Ga.  
 GXL 8" Leads  
 Mercury Sable '90 - UP,  
 Ford Taurus '86 - UP  
 Box Qty. 1

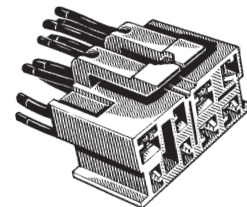

## 400677

Repair Harness - Headlamp Switch  
 Fits #E64Y-11654-A  
 (Motorcraft SW-1975)  
 5 - 18 Ga., 2 - 14 Ga., 1 - 12 Ga.  
 GXL 8" Leads  
 Mercury Sable '86 - '99  
 Box Qty. 1



## 400678

Repair Harness - Fan Speed Switch  
 Switch #E6DZ-19986-A &  
 E9SZ-A, F2DZ-A, F2UZ-A & B  
 2 - 12 Ga., 1 - 14 1 - 16 Gauge  
 GPT 8" Leads  
 Ford Taurus/Sable '86 - '93,  
 T-Bird/ Cougar '89 - '93  
 Box Qty. 1

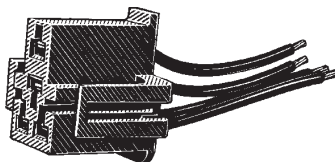

## 400681

Repair Harness -  
 A/C Blower Motor Resistor  
 #E7TZ19A706-A  
 4 - 18 Ga. 8" Leads  
 Ford Trucks '86 - UP  
 Box Qty. 1

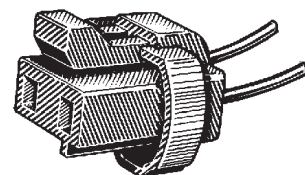

## 400682

Repair Harness - A/C Cycling Switch  
 Fits Switch #E35Y-19E561-A  
 2 - 16 Ga. 8" PVC Wire Leads  
 Ford '83 - UP  
 Box Qty. 1

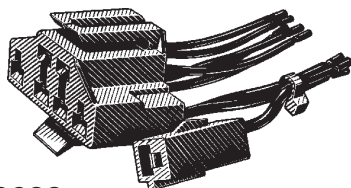

## 400683

Repair Harness - EEC IV Test Plug  
 (2 Connectors)  
 7 - 18 Ga. Leads PLUS  
 1 - 18 Ga. Lead 8" GXL Wire  
 Ford Products '83 - UP  
 Box Qty. 1

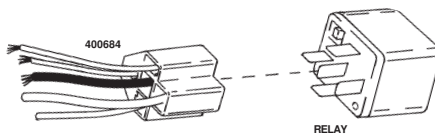

## 400684

Rep: 12102696, PT363  
 Repair Harness -  
 Various Accessory Relays  
 5-16 GA GXL 8" Leads  
 General Purpose  
 Ford, Chrysler,  
 GM '80 - UP  
 Box Qty. 1

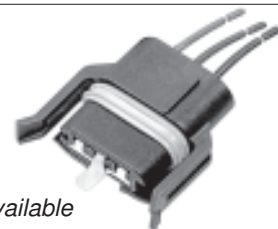

## 400685

OEM # Not Available  
 Harness Connector  
 Plugs Into Light Socket Base For  
 Double Filament Wedge Type Bulbs  
 Stop, Tail, Turn & Parking Lights  
 Ford Ranger, Explorer &  
 Econoline '91 - UP  
 Box Qty. 1

# FORD PIGTAIL SOCKET ASSEMBLIES

Electrical



## 400687

*OEM # Not Available*  
 Straight Lamp Socket Base  
 Repair Harness  
 Wedge Bulb  
 Three 18 gauge TXL 8" Leads  
 Ford Windstar '95 - UP  
 Box Qty. 1

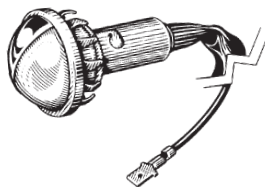

## 400690

Shielded License/ Utility Light  
 Sealed Socket Assembly  
 w/ Chrome Plastic Shield  
 14" Sealed Plastic Boot  
 28" Lead w/ Male Spade Terminal  
 Bulb Included - Mounts In 1-1/4" Hole  
 Universal  
 Box Qty. 1



## 400701

*Not Supplied by OEM*  
 Power Brake Pigtail. 12" Leads  
 Eliminates Removing & Replacing  
 Entire Wiring Harness  
 Ford '65/.  
 Box Qty. 5

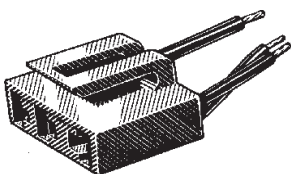

## 400702

*Not Supplied by OEM*  
 Repair Harness - Ignition Coil  
*Fits Coil E73Z-12029A*  
 w/Color Coded Wires  
 2-18 Ga., 1-16 Ga. 10" Leads  
 Ford Models '86 - UP  
 Box Qty. 6

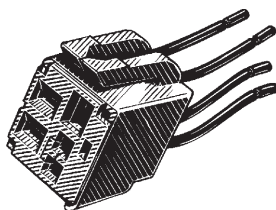

## 400710

Repair Harness - Fuel Pump Relay  
*E3FZ-9345-B*  
 4 Leads: 1 - 18 Ga., 2 - 16 Ga.,  
 1 - 14 Ga. 8" GPT Wire Leads  
 Ford '82 - UP  
 Box Qty. 1



## 400712

Repair Harness - EEC Relay  
*Relay E3AZ-12A646-A*  
 5 Leads: 2 - 18 Ga., 2 - 16 Ga.,  
 1 - 14 Ga. GPT 8" Leads  
 Ford '83 - UP  
 Box Qty. 1

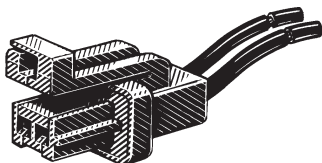

## 400713

Repair Harness - Engine Fan Switch  
*Switch #E43Z8B607-A*  
 2 - 14 Ga. 7" Leads  
 Gray Connector  
 Ford '84 - UP  
 Box Qty. 1 Kit

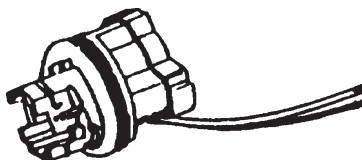

## 400714

Repair Harness - Rear Lamps  
*For #3156 Wedge-Style Bulb*  
 2 - 18 Ga. 8" GPT Wire Leads  
 Ford '87 - UP  
 Box Qty. 1



## 400715

Repair Harness -  
 Idle Air By-Pass Valves  
*w/ Base #PF715*  
 1 - 18 Ga., 1 - 16 Ga. GPT 8" Leads  
 Ford  
 Also Headlamp Switch  
*Switch #E7ZZ-11654-B (SW2106)*  
 Ford Mustang '88-'93 w/Fog Lamps  
 Box Qty. 1

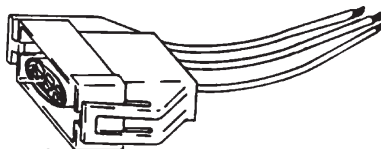

## 400716

Repair Harness -  
 Throttle Position Sensor  
 3 - 18 Ga. GPT 8" Leads  
*Sensor Base #9B989*  
 Ford Taurus, Sable '90 - UP;  
 Ranger, Explorer, Escort '91 - UP;  
 Crown Victoria, Marquis '92 - UP  
 Box Qty. 1

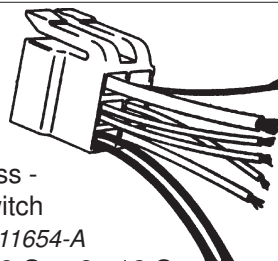

## 400717

Repair Harness -  
 Headlamp Switch  
*Switch #E7ZZ-11654-A*  
 8 Leads: 6 - 18 Ga., 2 - 12 Ga.  
 GPT 8" Leads  
 Ford Mustang '87 - '93  
*Also Switch #E7ZZ-11654-B (SW2106)*  
*w/ Fog Use #400715*  
 Box Qty. 1



## 400718

Repair Harness -  
 Alternator Regulator,  
 A/C Clutch Field  
 1 - 16 Ga. GPT 8" Lead  
 Ford Various Models '94 - UP  
 Box Qty. 10

# FORD PIGTAIL SOCKET ASSEMBLIES

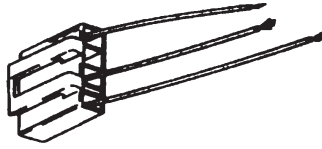

## 400719

Use with #400630  
 Repair Harness - Headlight Switch  
 Switch #'s F2AZ,-11654-A,  
 F3VY-11654-A, F2AZ-11654B  
 1 - 16 Ga., 1 - 18 Ga., 1 - 20 Ga.  
 GPT 8" Leads  
 Ford & Lincoln '92 - '94  
 Box Qty. 1



## 400720

Repair Harness -  
 Aux. Blower Switch  
 Switch #F2UZ-19986-C, YH-538  
 3 - 12 Ga. GPT 8" Leads  
 1 - 14 Ga. GPT 8" Lead  
 1 - 18 Ga. GPT 8" Lead  
 Ford Full Size Vans '92 - UP  
 Box Qty. 1 Kit

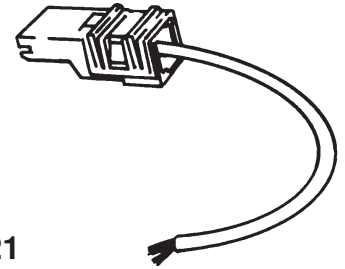

## 400721

Repair Harness -  
 Starter Solenoid In-line Repair  
 1 - 12 Ga. GXL 8" Lead  
 Ford & Lincoln T.C. '91 - '97  
 Box Qty. 1

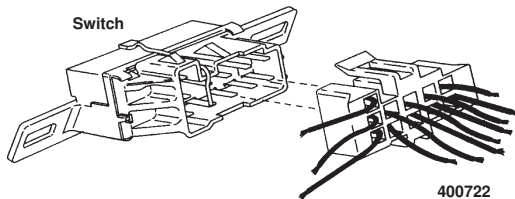

## 400722

F6HZ-14A464-FUA  
 Repair Harness - Ignition Switch  
 Switch # D7AZ-11572-A, SW 1379  
 15 Leads: 2 - 8 Ga., 4 - 12 Ga., 1 - 14 Ga.,  
 2 - 16 Ga., 5 - 18 Ga., 1 - 24 Ga.  
 Ford Cars & Trucks '70 - '77  
 Box Qty. 1

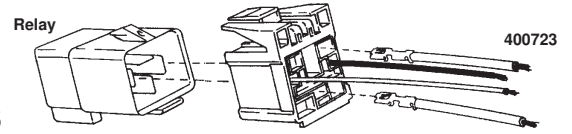

## 400723

Repair Kit - Horn & Blower Relays  
 Relay #F0A8-14B193-AB  
 Kit Contains: 1 Connector, 1 Lock &  
 1 Each: 10 Ga., 12 Ga., 14 Ga., 16 Ga.,  
 18 Ga. SXL 4" Leads  
 Wire Position is Based On Existing  
 Wire Configuration  
 Ford Cars and Trucks  
 Box Qty. 1 Kit



## 400724

In-Tank Fuel Pump &  
 Sending Unit Connector  
 Ford '85 - UP  
 Box Qty. 1

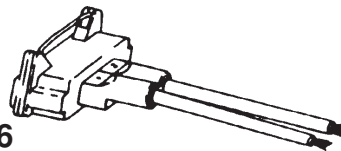

## 400726

Repair Harness -  
 Radiator Cooling Motor & Resistor  
 Resistor # F5RZ-8L603-AC  
 Motor #'s F5RZ-8C607-B, F8RZ-8C607-  
 GC, F8RZ-8C607-GE, RF28, RF76, RF81  
 2 - 12 Ga. GXL 8" Leads  
 Ford Contour, Mystique,  
 Mercury Cougar '95 - UP  
 Box Qty. 1

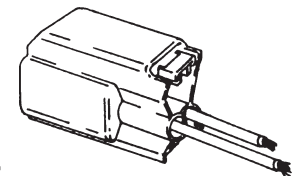

## 400727

Repair Harness -  
 Cam Shaft & Crank Shaft Sensors  
 Sensor #'s F0CZ-6B288A, F1AZ-6C315-  
 A, F1AZ-6B288-A, XC3Z-6B288-AA  
 2 - 18 Ga. GXL 8" Leads  
 Ford Cars & Lt. Duty Trucks '91 - UP  
 Box Qty. 1



## 400731

Injector/  
 Glow Plug Pass Through  
 At Valve Cover Gasket  
 (1/HEAD) Valve Cover Gasket  
 #F81Z-6584-AA  
 5-18 ga. & 4-14 ga. TXL 8" Leads  
 Ford E & F Series Trucks 7.3  
 Diesel '98  
 & Excursion 2000  
 '95 - 97  
 Box Qty. 1



## 400732

Injector/Glow Plug Pass Through  
 At Valve Cover Gasket  
 (2/HEAD) Valve Cover Gasket  
 #F4TZ-6584-A  
 2-16 ga. & 3-18 ga. TXL 8" Leads  
 Ford E & F Super Duty &  
 Excursion Trucks 7.3 Diesel  
 '95 - 97  
 Box Qty. 1

# FORD PIGTAIL SOCKET ASSEMBLIES

## REPAIR HARNESSSES FOR FORD MULTI-FUNCTION SWITCHES

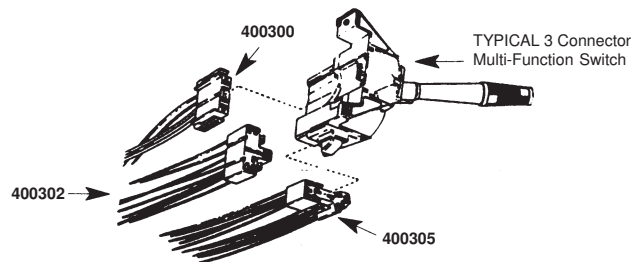
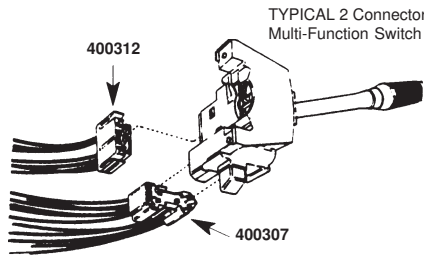

**400300**  
2-16 Ga. (GPT) & 2-12 Ga. (GPT)  
Leads 8" Length  
Box Qty. 1



**400302**  
9-16 Ga. (GPT)  
Leads 8" Length  
Box Qty. 1



**400305**  
10-16 Ga. (GPT)  
Leads 8" Length  
Box Qty. 1

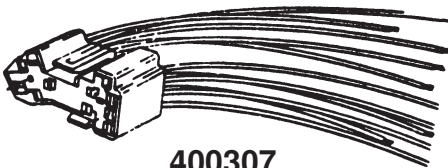

**400307**  
11-18 Ga. (TXL) Leads 8" Length  
Box Qty. 1



**400312**  
3-20 Ga. & 4-16 Ga. (TXL) Leads 8" Length  
Box Qty. 1

### FORD MULTI FUNCTION SWITCH BASE NO. 13K359

### REPAIR HARNESS

No. 13K359	M/C No.	APPLICATION	UNIT PACKAGE 1		
E8DZ-B	SW-2441	86/89 Taurus, Sable W/O Intermittent	400300	400302	400305
E8ZZ-B	SW-2443	87/89 Mustang	400300	400302	400305
E9DZ-A	SW-2444	86/89 Taurus, Sable W/ Intermittent	400300	400302	400305
E9DZ-B	SW-2444	86/89 Taurus, Sable W/ Intermittent	400300	400302	400305
E9DZ-C	SW-2444	86/89 Taurus, Sable W/ Intermittent	400300	400302	400305
E9OY-D	SW-2446	88/90 Continental, Town Car	400300	400302	400305
E9SZ-B	SW-2447	89/93 T. Bird, Cougar, W/O Auto Dimmer	400300	400302	400305
E9SZ-D	SW-2447	89/93 T. Bird, Cougar, W/O Auto Dimmer	400300	400302	400305
E9SZ-E	SW-2448	89/93 T. Bird, Cougar, W/ Auto Dimmer	400300	400302	400305
FOZZ-A	SW-2453	90/93 Mustang	400300	400302	400305
FOZZ-B	SW-2453	90/93 Mustang	400300	400302	400305
F1AZ-A	SW-2454	91-94 Ford, Merc, Continental T. Car	400305	400312	
F1AZ-B	SW-2454	91-94 Ford, Merc, Continental T. Car	400305	400312	
F1DZ-B	SW-2461	90/ Taurus, Sable	400307	400312	
F1LY-B	SW-2466	90/92 Lincoln Mark	400305	400312	
F1OY-D	SW-2468	91/95 Lincoln Continental	400305	400312	
F1VY-C	SW-2469	90/94 Lincoln T. Car	400305	400312	
F3TZ-B	SW-2485	92/95 F Pickup, Bronco, Aerostar	400305	400312	
F3UZ-C	SW-2484	92/95 E Van, Aerostar W/ Auto Dimmer	400307	400312	
F6DZ-A	SW-5083	96 Taurus, Sable	400307	400312	